

GTC-200A Wall Mount
< 8 Slot Type Component Assembly >

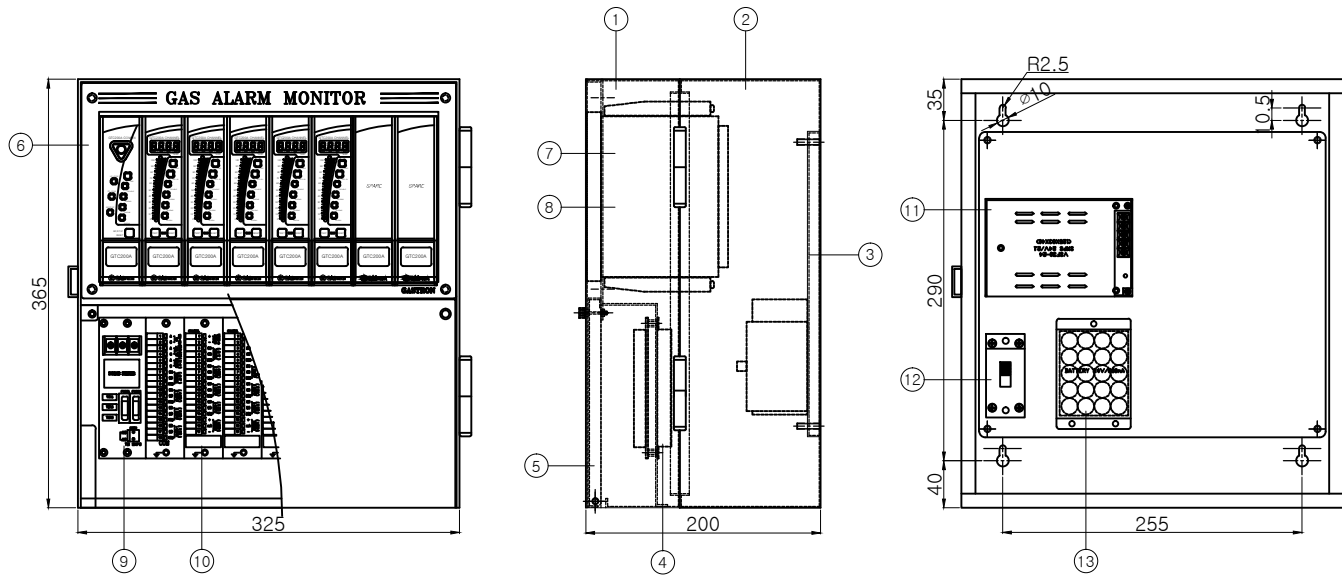

No.	Description	Material	Q'ty	REMARK
1	Front case	S41C	1	White Gray
2	Rear case	S41C	1	White Gray
3	Inner plate	S41C	1	White Gray
4	Cable Cover	S41C	1	White Gray
5	Front cover	S41C	1	White Gray
6	Name plate	Acryl	1	Black Brown
7	Din case-WM (COM)	.	1	.
8	Din case-WM (CH)	.	7	.
9	MOTHER BOARD COMMON PCB	FR4	1	94V0
10	MOTHER BOARD CHANNEL PCB	FR4	1	94V0
11	Power Supply	.	1	Fine Suntronix
12	MCCB	.	1	LG BS32a(15A)
13	Battery	.	1	GREEN POWER
14	SCRHS-S-M3-6-NIP	Steel	10	.
15	SCPH-M4-25-천연색	Steel	2	.
16	CIRCUIT BREAKER-BS	.	1	.
17	Flat-40P-ST5-2.54-300	.	1	.

GASTRON CO., LTD.

Title GTC-200A Series

Project No. 8 Slot Type Composition

Part No. 1300510-0005-00

Material S41C 1.2t **Scale** 1/1

Pro-jection **Units** mm

DWG. No. G-000000 **Rev.**

General Note

1. Tolerance Limits : ±1.0
2. No indications R=0.5, C=0.5
3. No indications surface processing: ≤12S()
4. Color: Lucoat ED4243
- 5.

Rev.	Description	Date	Drawn	Checked	Approved
	Formation change	04.08.2014	K.H. LEE	K.H. LEE	S.K. CHO
	For issued	04.08.2010	S.M. SHIN	S.M. SHIN	S.K. CHO