



Headquarters / Engineering research laboratory :  
23 Gunpo Advanced Industry 1-ro(Bugok-dong), Gunpo-si, Gyeonggi-do  
Tel +82-31-490-0800 Fax +82-31-490-0801

Yeongnam business office / Plant :  
55 Gonghangap-gil 85beon-gil, Gangseogu, Busan Metropolitan City  
Tel +51-973-8518 Fax +51-973-8519

E-mail : info@gastron.com

www.gastron.com

# GTC-200F

## Instruction Manual



Read in detail for correct use.

# Gas & Flame Detection System

**GASTRON**



When abnormalities occur after purchasing the product,  
please contact the following address.

- Address : 23 Gunpo Advanced Industry 1-ro,  
Gunpo-si, Gyeonggi-do
- Tel : 031-490-0800
- Fax : 031-490-0801
- URL : [www.gastron.com](http://www.gastron.com)
- e-mail : [info@gastron.com](mailto:info@gastron.com)

## We sincerely thank you for purchasing the product of Gastron Co. Ltd.

Our Gastron Co.Ltd. is a company specialized in Gas detector and Gas Monitoring System, being recognized by many consumers due to the best quality and use convenience. We always enable you consumers to find desired products nearby and are ceaselessly studying and striving for development of Gas detectors satisfying customers. From now on, solve all anguishes concerning Gas detector with the products of Gastron Co. Ltd, We Gastron Co. will take a responsibility and give you satisfaction.

In the present instruction manual, operation method for Gas detector as well as simple methods for maintenance and repair, etc. are recorded. If you read it in detail and keep it well, for reference when you have questions, then it will give you much help.

- For accurate operation of Gas detector, check up and calibrate for more than once in every 6 months.  
( \* See No. 13 of KOSHA GUIDE : P-135-2013 / 8.3 paragraph on qualification and calibration)
- For accurate operation of Gas detector, checkup and calibration with calibration gas before measurement is recommended.
- When not calibrated, it may cause malfunction of the equipment due to problems resulting from Sensor aging.
- When the present instrument should be dismantled, those with professional skills for Gas detector should conduct the operation.
- For power supply cable, wire specifications should be determined by referring to the item of "Length of installed cable".
- For the contents on checkup and calibration of Gas detector, please use our company's engineering department , e-mail, or web site.

The present product and the product manual can be changed without advance notice for performance improvement and use convenience of the product.

\* KOSHA GUIDE : P-135-2013

Calibration should be executed at periods required by the manufacturer, and should be executed in every quarter unless there are separate calibration periods.

<b>1. Overview</b> .....	6	<b>9. How to operate Channel Unit</b> .....	23
<b>2. Features</b> .....	6	9.1. Power ON .....	23
<b>3. Basic specifications</b> .....	7	9.2. Gas Measuring Mode .....	23
<b>4. Specifications for channel card</b> .....	8	9.3. Test Mode .....	24
4.1. Common Alarm Unit .....	8	9.4. Checkup mode (Stand-by Mode) .....	24
4.2. Channel Control Unit .....	9	9.5. Operation setting .....	25
4.3. Power Unit (Option) .....	9	9.5.1. Program Mode .....	25
<b>5. Name and description of each part</b> .....	10	9.6. ALARM Mode .....	27
5.1. Basic configuration and description .....	10	9.7. Maintenance Mode .....	29
5.2. Configuration and description of Power unit .....	11	<b>10. Outline drawing and Dimensions</b> .....	31
5.3. Configuration and description of warning unit (Common unit) .....	13	10.1. Basic configuration .....	32
5.4. Configuration and description of concentration display unit(Channel unit) .....	15	10.2. Power unit .....	32
<b>6. Installation</b> .....	17	10.3. Common Unit .....	30
6.1. Separation of Cover .....	17	10.4. Channel Unit .....	33
6.2. Power supply and signal configuration for Channel Unit .....	17	<b>11. Notes before installation</b> .....	34
6.3. Configuration of channel Unit terminal .....	18	11.1. Selection of installation place (Data from Occupational safety and health regulations) .....	34
6.4. How to connect 3 wire type Gas detector .....	19	11.2. Selection of installation place (Data from safety management regulations on for high-pressure gas) .....	34
6.5. How to connect 2 wire type Gas detector .....	19	11.3. Notes upon installation .....	34
<b>7. How to operate Power unit</b> .....	20	<b>12. Revision record</b> .....	36
<b>8. How to operate Common Unit</b> .....	21		
8.1. Function .....	22		
8.2. RS485 MODBUS Interface .....	22		
8.2.1. Communication setting .....	22		
8.2.2. RS485 MODBUS communication setting and Register .....	22		

GTC-200F Series is ammeter with adoption of high-performance A/D Converter and Micro-Process, and has diversified functions embedded. GTC200A Series is configured as a centralized type, being comprised of a Common alarm unit and a Multi-Channel control unit, with the Multi channel control unit being connected to each detector.

GTC-200F Series is protected by a case of DIN Type, and has Wall mount type products with an explosion-proof case. GTC-200F Series has FND Digital display (PV Value) function and 3-color LED Bar Graphic display (PV and Alarm set value) embedded, with 3 Instant alarm functions(1st H/L, 2nd H/L, 3rdH/L) and breakdown alarm (Trouble alarm).

## 2. Features

GTC-200F Series has Audible(Buzzer) and Visual(Alarm LED and Bar graphic LED flashing) responses upon occurrence of Instant alarm and Trouble alarm, with Max. PV Value holding functions upon occurrence of alarm. GTC200A Series is capable of remote control for alarm clearing, and can perform interlocked control functions since it has an output for alarms (SPDT Contact).

Common alarm unit of GTC200A Series is supplying communication output (Isolation type RS-485 : Option) to configure Monitoring system such as Gas vision, etc. while each Channel control unit is supplying an output (4~20mA. DC) for measured values.

GTC200A Series is configured with the latest parts, being equipped with stability and reliability, is capable of maximum expansion (Max. 4channel) within a given space.

ITEMS	SPECIFICATION
Input power supply	AC 110V/220V 50/60Hz (Basic AC220V 50/60Hz)
Applicable specification for SMPS	24V 1.5A (24V 1.5A)
Alarm display	Audio signal- Audible(Buzzer) and Visual signal- Visual(LED)
Alarm clearing	Return switch- Manual (Reset switch)
Control input	Outside pressure (Remote reset) - Buzzer stop/ return function
Measured output	Isolation RS-485 modbus(Optional)
Backup power unit(Optional)	24V DC/600mA
	24V DC/1300mA
Explosion-proof specification	Explosion proof type (Ex d IIB T5) KCs
Approval	CE, KR, KFI
Size	415(W) * 315(H) * 287(D) mm
Weight	App. 30Kg
Operation Temperature	-20 to 40 °C
Storage Temperature	-20 to 40 °C
Operation Humidity	5 to 99% RH (Non-condensing)
Pressure Range	90 to 110KPa

### 4.1. Common Alarm Unit

ITEMS	SPECIFICATION
Input form	RS-485
Input measuring period	100ms
Alarm display	Audio signal- Audible(Buzzer) and Visual signal- Visual(LED)
Alarm clearing	Return switch- Manual (Reset switch)
Control input	Outside input(Remote reset) - Buzzer stop/return function
Measured output	Isolation RS-485 modbus(Optional)
Alarm output	Buzzer - Buzzer SPST Relay dry contact signal output
	Breakdown alarm - SPDT Relay Dry contact signal output
	1st alarm - Alarm 1 SPDT Relay dry contact signal output
	2nd alarm - Alarm 2 SPDT Relay dry contact signal output
	3rd alarm - Alarm 3 SPDT Relay dry contact signal output
	Relay dry contact capacity : AC250V/3A, 30V/3A
Operation power supply	DC 24V / 100mA Max

### 4.2. Channel Control Unit

ITEMS	SPECIFICATION	
Input form	Analog 4-20mA	
Measurement display	4-Digit FND and Bar-graph (32 segment, 3-color LED)	
Measuring range	0.000 to 9999 Digital (Arbitrary setting by user)	
Measurement accuracy	FND Digital	±1 % Full Scale
	LED Bar	±1 % Full Scale
Input measuring period	100 ms	
Alarm setting	3-stage alarm(Arbitrary setting by user)	
Alarm setting display	3 Color bar graphic (Green/Red/Yellow LED)	
Alarm display	LED bar graphic	
Alarm clearing	Manual (Common unit)	
Self diagnosis	Test switch and Reset switch	
Control input/output	RS-485	
Measured output	Analog 4-20mA	
Alarm output	Breakdown alarm	SPDT Relay dry contact signal output
	Alarm 1	SPDT Relay dry contact signal output
	Alarm 2	SPDT Relay dry contact signal output
	Alarm 3	SPDT Relay dry contact signal output
		Relay dry contact capacity : AC125V 10A
Operation power supply	DC 24V / 100mA Max	

### 4.3. Power Unit (Option)

ITEMS	SPECIFICATION
Input power supply	DC. 24V
Output power supply	DC. 24V (Reserve power supply : DC. 27V / 300mA)
Output power supply display	FND Digital display
Main power supply display	Green LED display
Reserve power supply display	Green LED display
Reserve power supply monitoring	Red LED display
Reserve power supply test	Test switch for reserve power supply
Reserve power supply	Ni-Cd Battery 24V / 600mA(less than 6 circuits)

### 5.1. Basic configuration and description

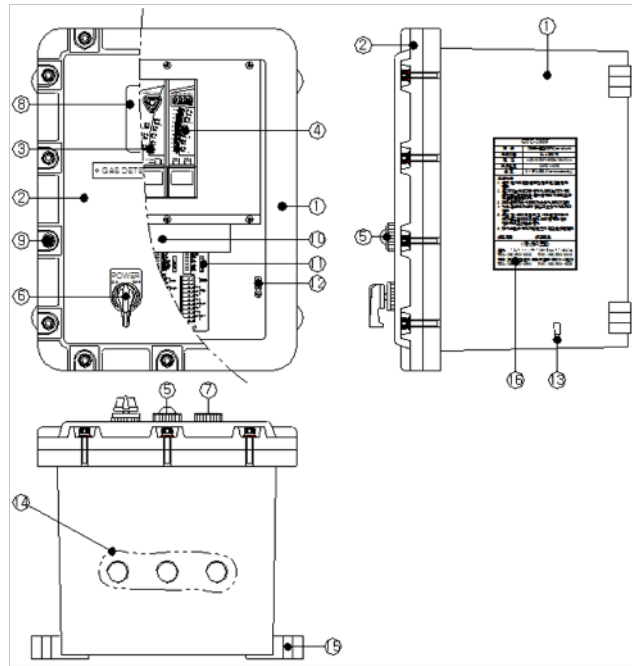

[Figure 1. Alarm configuration and explanation]

NO	NAME	DESCRIPTIONS
1	GTC-200F CONTROL UNIT BODY	Protects internal PCB, Power Supply, etc. from external environmental change and impact.
2	GTC-200F CONTROLUNIT COVER	It is combined with CONTROL UNIT BODY. There is a glass part on the upper part to check the current status.
3	COMMON ALARM UNIT	One to four channel units will sound an alarm when an alarm occurs, and will stop and reset the buzzer.
4	CHANNEL UNIT	Indicates the concentration of connected GAS DETECTOR, usually 1~4 installed.
5	ALARM LAMP	It blinks when an alarm occurs and informs it visually.
6	POWER SWITCH	Power ON / OFF. (If you need to open the cover of the control unit, be sure to turn off the power before performing the operation.)
7	RESET BUTTON	Release the alarm.

NO	NAME	DESCRIPTIONS
8	TEMPERED GLASS	State of inside can be checked with 10mm of tempered glass.
9	WRENCH BOLT	Used for coupling of COVER and BODY. (M8x1.25 TAP, Length=53mm)
10	POWER SUPPLY	Power supplied to COMMON and CHANNEL UNITS as well as GAS DETECTOR. (Input AC110/220V, Output DC24V/3.5A)
11	TERMINAL PCB	Power supply and each CHANNEL, Used for wire connection of detector
12	Internal ground (more than 2sq)	Inside grounding is connected upon product release, while outside grounding is connected by cable of more than 2sq after product mounting.
13	External ground (more than 2sq)	Inside grounding is connected upon product release, while outside grounding is connected by cable of more than 2sq after product mounting.
14	Cable Inlet (PF 3/4")	Used for lead-in of power supply and signal cable, and designed to allow connection of PF3/4" piping.
15	CASE fixing hole	4 ea. of 12mm holes machined to allow mounting of CASE.
16	Product Nameplate	Simple note such as model name, explosion-proof class, etc. described

[Table 1. Description of basic configuration]

### 5.2. Configuration and description of Power unit

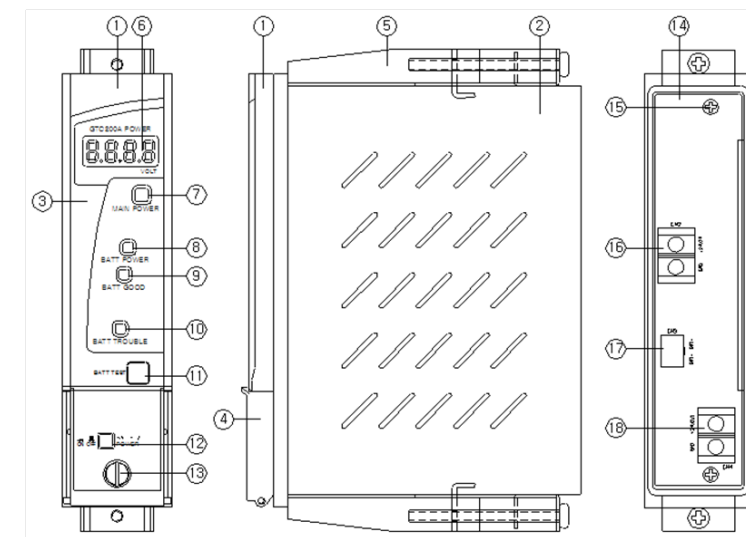

[Figure 2. Configuration of power supply unit]

NO	NAME	DESCRIPTIONS
1	Front cover case	Front-face Cover for Power Unit
2	Main body case	Main Body for Power Unit
3	Acrylic	Acryl for protection of front-face cover for Power Unit
4	Front sub cover	Front-face Sub cover for Power Unit
5	Main body fixed bracket	Bracket for mounting of Power Unit
6	Main/Battery power display	Main power voltage and battery voltage displayed. Voltages of power supplied to Common unit and channel unit are displayed
7	Main power LED	When AC power supply is used. Main power supply LED is lighted, and it is turned off when reserve power supply is used.
8	Battery power LED	When reserve power supply is used rather than AC main power supply, reserve power supply LED is lighted.
9	Battery power good LED	Lighted when reserve power supply is connected and normal with voltage higher than 18V.
10	Battery power trouble LED	Lighted when reserve power supply voltage is lower than 18V, and blinking when reserve power supply is not connected.
11	Battery power test key	It is a switch for testing whether reserve power supply operates normally. When the switch is pushed, voltage of the reserve power supply is applied to operate the gas leakage alarm. At this time, voltage of the reserve power supply is displayed in FND.
12	Battery power ON/OFF switch	It is the on/off switch for reserve power supply. Note1) It is turned off upon product shipment Note2) Switch for the reserve power supply should be turned on after the main power supply is turned on .
13	Front cover screw	Screw for fixing of Power unit
14	Terminal PCB	Power Unit Terminal PCB
15	Terminal PCB screw	Screw for fixing of Power Unit Terminal PCB
16	DC input connector	Inputting connector for Power supply of Power Unit
17	Battery connector	Inputting connector for reserve power supply of Power Unit
18	DC output connector	Power supply output connector for operation of channel card

[Table 2. Description on configuration of power supply unit]

### 5.3. Configuration and description of alarm unit (Common unit)

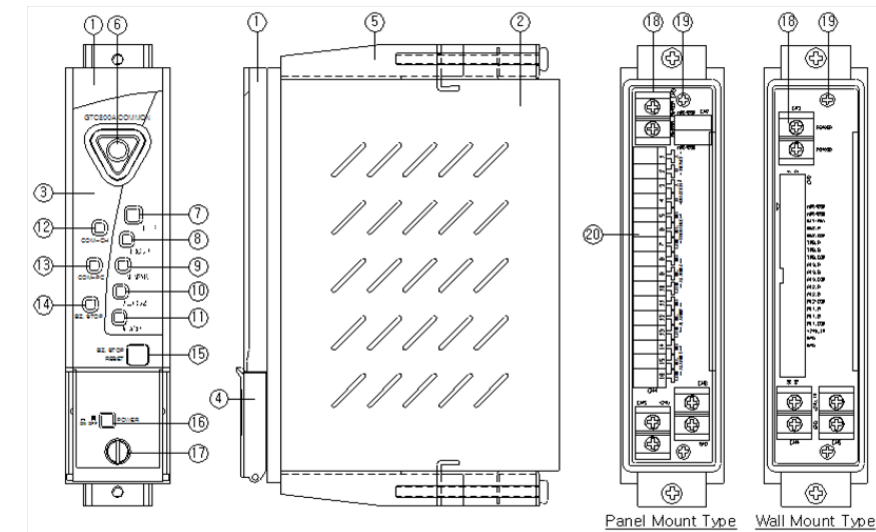

[Figure 3. Configuration and description of alarm unit]

NO	NAME	DESCRIPTIONS
1	Front cover case	Front-face Cover for Common unit
2	Main body case	Front-face main Body for Common unit
3	Acrylic	Acryl for protection of front-face cover for Front-face main Body for Common unit
4	Front SUB cover	Front-face Sub cover for Common unit
5	Main body fixed bracket	Bracket for mounting of Common unit
6	Buzzer	Operating with intermittent sound of each upon occurrence of Alarm and Trouble in each Channel
7	Power LED	Power LED is lighted when power is inputted in Common unit
8	Trouble LED	Trouble LED is lighted upon occurrence of Trouble in each Channel Unit. Ex) Upon occurrence of defective wire connection with detector and of abnormality
9	Alarm-3 LED	Alarm 3 LED is lighted upon occurrence of the 3rd alarm in each Channel unit. Alarm 3 LED is lighted when the 3rd alarm value is reached upon execution of test function in each channel
10	Alarm-2 LED	Alarm 2 LED is lighted upon occurrence of the 2nd alarm in each Channel unit. Alarm 2 LED is lighted when the 2nd alarm value is reached upon execution of test function in each channel

NO	NAME	DESCRIPTIONS
11	Alarm-1 LED	Alarm 1 LED is lighted upon occurrence of the 1st alarm in each Channel unit. Alarm 1 LED is lighted when the 1st alarm value is reached upon execution of test function in each channel
12	Communication LED (Channel)	When normal communication is realized with entire channel units set in the channel unit COM-CH LED continues to be lighted, while COM-CH LED blinks if there is a channel unit without realization of communication. (When the No. of Channel units is set as less than 1 ea. In common unit, it blinks at an interval of 0.5 sec.)
13	Communication LED (PC)	When communication DATA transmitted from PC is normally received in common unit, COM-PC LED is immediately turned off after being lighted once.. (When the No. of Common unit addresses is set as less than 1 ea. In common unit, it blinks at an interval of 0.5sec.)
14	Buzzer stop LED	As the Alarm occurs in channel unit, buzzer operates. When Buzzer stop is pushed, the buzzer is stopped, at this time BZ-STOP LED is lighted. When the Buzzer stop is pushed once more in Common unit or Channel unit, BZ-STOP LED is turned Off. (However, it is lighted only when Alarm type was set for hold in the channel unit)
15	Buzzer Stop/Reset key	It is a key used for Buzzer stop and Reset upon occurrence of trouble and alarms in each channel unit. Push once initially.... Buzzer sound is stopped and BZ-STOP LED is lighted. Push twice consecutively.... BZ-STOP LED is turned Off, and Reset function of all Channel units in Latch state according to Alarm setting is executed.
16	Power ON/OFF switch	Power ON/OFF switch of Common unit
17	Front cover screw	Screw for fixing of Common unit
18	Terminal PCB	Common Unit Terminal PCB
19	Terminal PCB screw	Screw for fixing of Common Unit Terminal PCB
20	Connector	Input connector for signals

[Table 3. Description on configuration of alarm unit]

5.4. Configuration and description of concentration display unit (Channel unit)

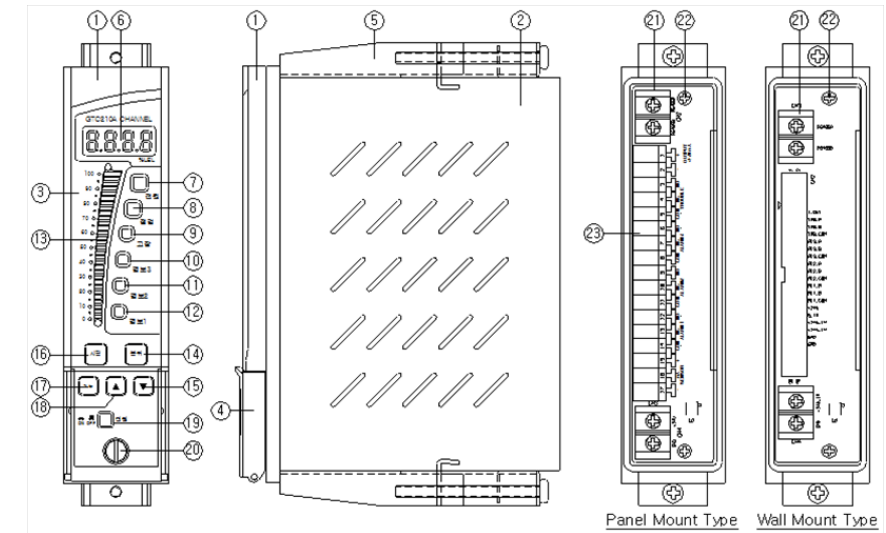

[Figure 4. Components of concentration display unit]

NO	NAME	DESCRIPTIONS
1	Front cover case	Front-face Cover for Channel control unit
2	Main body case	Main Body for Channel control unit
3	Acrylic	Acryl for protection of front-face cover for Channel control unit
4	Front sub cover	Front-face Sub cover for Channel control unit
5	Main body fixed bracket	Bracket for mounting of Channel control unit
6	FND display	Measured values of the detector connected to each channel continues to be displayed, while user designated value is displayed in blinking state upon execution of test function.
7	Power LED	When Power is inputted in channel unit, Power LED is lighted.
8	Checkup LED	STD-BY LED blinks when it is in checkup mode for detector.
9	Trouble LED	Trouble LED is lighted upon occurrence of trouble in channel unit and detection unit. Ex) Upon occurrence of defective wire connection with detector and of abnormality
10	Alarm-3 LED	Upon occurrence of the 3rd alarm in channel unit, Alarm 3 LED is lighted. Alarm 3 LED is lighted when the 3rd alarm value is reached upon execution of test function in the channel unit.



NO	NAME	DESCRIPTIONS
11	Alarm-2 LED	Upon occurrence of the 2nd alarm in channel unit, Alarm 2 LED is lighted. Alarm 2 LED is lighted when the 2nd alarm value is reached upon execution of test function in the channel unit.
12	Alarm-1 LED	Upon occurrence of the 1st alarm in channel unit, Alarm 1 LED is lighted. Alarm 1 LED is lighted when the 1st alarm value is reached upon execution of test function in the channel unit.
13	3 color bar graphic LED	3 Color bar graphic LED continues to display measured values and alarm setting values together with FND display. Bar graphic LED is lighted in green when the measured value is less than the 1st Alarm, in orange when it is more than the 1st Alarm and less than the 2nd Alarm, and in red when it is more than the 2nd Alarm. When the measured value is more than the alarm setting value, Bar graphic is held at the maximum value, and Bar graphic is displayed in blinking state for the alarm.
14	Reset key	Functions of Channel unit such as Alarm clearing, Self test clearing, Program setting clearing, etc. are performed.
15	Down key	Arbitrary values can be selected by using "▲", "▼" Keys after each mode is selected with Func. Key. When "▲", "▼" Key is being pushed for a given time in the mode requiring many changes in setting value, the setting values are changed fast,
16	Test key	When Test switch is pushed, the mode of executing self-diagnosis function is entered into. It is a key where the measured value FND blinks, and Alarm operation state can be checked in Channel unit and Common unit by using "▲", "▼" Key to adjust measured values that are blinking. Diagnosis is cleared by pushing once of the Reset key in each channel.
17	Function key	Function key is a key where Data values are inputted by conversion and selection of functions such as setting of alarm values, setting of alarm methods, setting of Dead band and of delay operation for alarm , etc.
18	Up key	Arbitrary values can be selected by using "▲", "▼" Keys after each mode is selected with Func. Key. When "▲", "▼" Key is being pushed for a given time in the mode requiring many changes in setting value, the setting values are changed fast,
19	Power ON/OFF switch	Power ON/OFF switch for Channel unit.
20	Front cover screw	Screw for mounting of Channel unit
21	Terminal PCB	Channel Unit Terminal PCB
22	Terminal PCB screw	Screw for mounting of Channel Unit Terminal PC
23	Connector	Output connector for signals

[Table 4. Description of density display component]

6.1. Separation of Cover

- Unfasten 14 places displayed by arrows in the above figure by using a 6mm hexagonal Wrench.
- (Caution) No one other than approved users or those of the headquarters in charge of installation and repair should never been allowed to install in the field or open or operate the cover for the installed Control Unit. Otherwise, serious damages to life and property such as fire or explosion accidents may be inflicted.
- (Caution ) Make sure to shut off power supply for operation after checking whether any explosive GAS remains or there is any flammable substance in the surroundings.

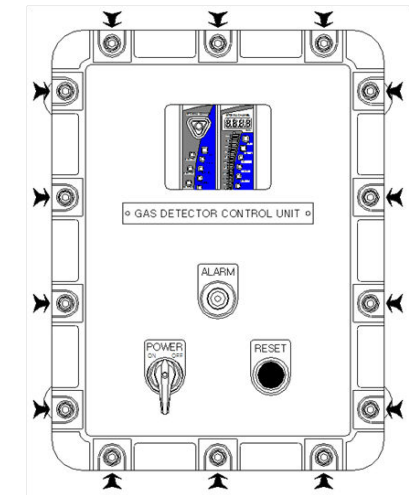

[Figure 5. Separation of Cover]

6.2. Power supply and signal configuration for Channel Unit

- Configurations for channel Unit, Common Unit and power Unit are as shown in the following figure with the channel Unit allowing the maximum configuration of 63 ea.

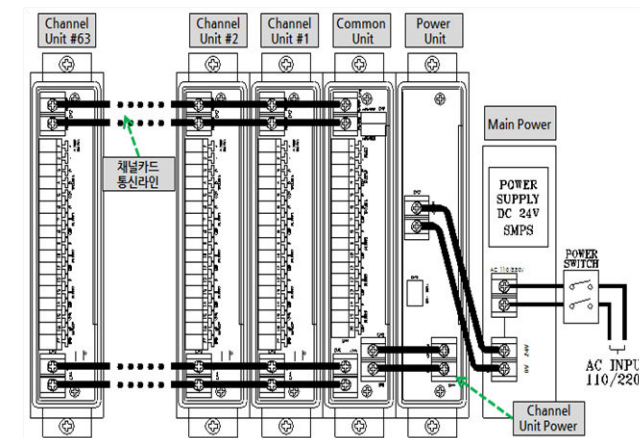

[Figure 6. Power supply and signal configuration for Channel Unit]

- The power unit is installed only when the battery is used.
- When not using the power unit, connect DC24V directly to the connector (CN6) of the common unit in the power supply. (Power unit is optional.)

6.3. Configuration of channel Unit terminals

NO	TERMINAL CONFIGURATION	DESCRIPTION
1	Output 4-20mA +	4-20mA output of measure values of detection unit
2	Output 4-20mA -	
3	TROUBLE RELAY NO	Output Relay for breakdown state
4	TROUBLE RELAY NC	
5	TROUBLE RELAY COM	
6	Alarm3 RELAY NO	Output Relay for 3rd alarm
7	Alarm3 RELAY NC	
8	Alarm3 RELAY COM	
9	Alarm2 RELAY NO	Output Relay for 2nd alarm
10	Alarm2 RELAY NC	
11	Alarm2 RELAY COM	
12	Alarm1 RELAY NO	Output Relay for 1st alarm
13	Alarm1 RELAY NC	
14	Alarm1 RELAY COM	
15	Power supply for detector +	Supply power to detection unit and input 4-20mA signals
16	4-20mA input for detector	
17	Power supply for detector -	

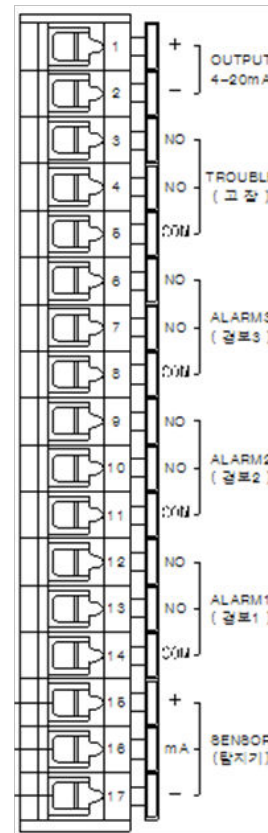

[Figure 7. Configuration of Channel Unit terminal]

6.4. Connection method of 3-wire type for Gas detector

- When the gas detector is configured with power supply and 4-20mA output using 3 wires(V+, mA, V-), connect to the channel unit by the following method.
- Connection cable should be configured with shield cable of CVVS or CVVSB of more than 1.5sq.

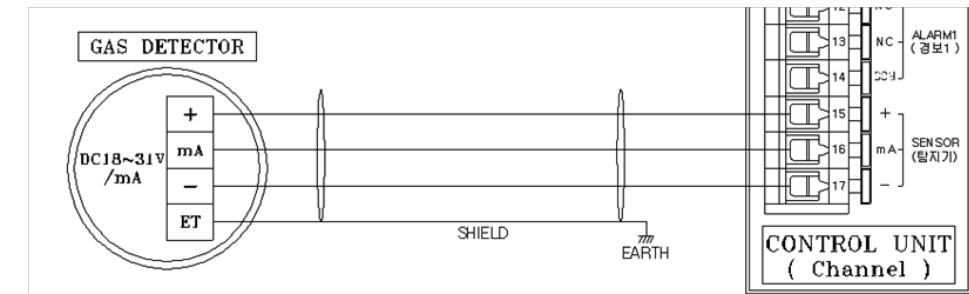

[Figure 8. 3-wire connection method for gas detector]

- Our company's detector models of the relevant method include TS-1100Ex, TS-2000Ex, TS-2100 Series, TS-4000 Series, TS-4100P Series, TS-5100 Series, GTD-1000 Series, GTD-2000 Series, GTD-3000 Series, and GIR-3000 Series.

6.5. Connection method of 2-wire type for Gas detector

- When output of gas detector is configured using 2-wires(V+, V-), connect to the channel unit by the following method.
- nection cable should be configured with shield cable of CVVS or CVVSB of more than 1.5sq.

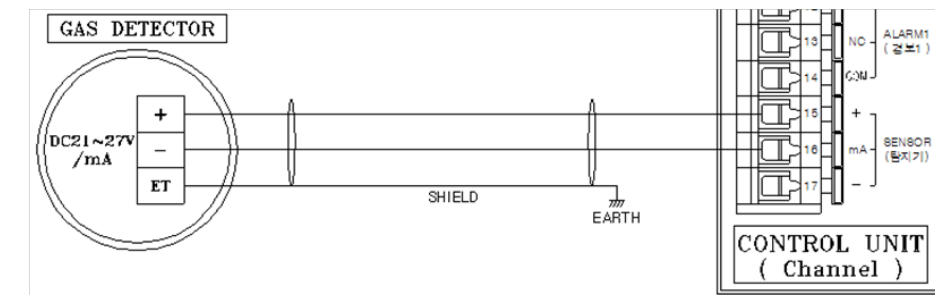

[Figure 9. 2-wire connection method for gas detector]

- Our company's detector models of the relevant method include TS-1100Tx, TS-2000Tx, TS-3000 Series, and TS-3100 Series.

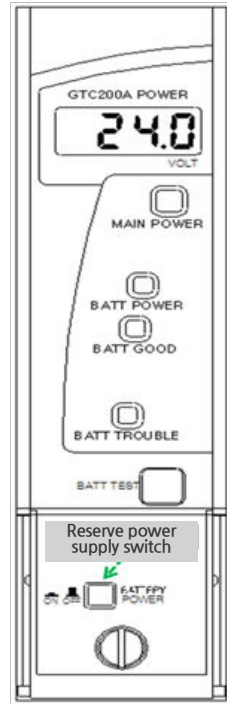

- Voltage of main power supply is displayed in FND Digital display s figures.
- When the checkup key for reserve power supply is pushed, the power supply is converted to the reserve power supply, with voltage of the reserve power supply being displayed in FND Digital display as figures.
- When reserve power supply is not connected, breakdown LED for reserve power supply blinks at an interval of 0.5 sec.
- When the reserve power supply is more than 18V, normal LED for reserve power supply is lighted, while breakdown LED for reserve power supply is lighted when it is less than 18V.

Note1) It is turned off upon product shipment.

Note2) Turn on the switch for reserve power supply after the main power supply is turned on.

### 8.1. Functions

NO	FUNCTION	DESCRIPTION
1	Buzzer alarm	When a breakdown signal is sent from the Channel unit, alarm sound occurs as a short intermittent sound. When alarm signal is sent from the Chanel unit, alarm sound occurs as a long intermittent sound.
2	Breakdown/Alarm LED	LED lighted when breakdown signal or alarm signal occurs in the Channel unit, with the alarm LED blinking during alarm maintenance time.
3	Communication LED	COM-CH LED displays communication state between Common unit and Channel unit, and is turned off after being lighted for about 0.1 sec upon communication for once. Thus, the continuously lighted state is maintained when normal communication occurs as many as the No. of Channel units set in the Common unit (Channel unit access time is 0.1sec). When communication DATA transmitted from PC is normally received in Common unit, COM-PC LED is immediately turned OFF by being lighted once. When SW1 and SW2 are set to be less than 1 ea. In Common unit, blinking occurs at an interval of 0.5sec(COM-CH/ COM-PC LED).
4	Buzzer-Stop LED	As an alarm occurs in Channel unit, the buzzer operates. The buzzer is stopped when Buzzer stop switch is pushed, at which time BZ-STOP LED is lighted (However, it is lighted only when Alarm type was set for hold in Channel unit). When the Buzzer stop is pushed once more in Common unit or channel unit, BZ-STOP LED is turned Off.
5	Buzzer stop and Reset key	A Key used for Buzzer Stop and Reset when Trouble and Alarm occurs in each Channel unit Push once initially.... Buzzer sound is stopped and BZ-STOP LED is lighted. Push twice consecutively.... BZ-STOP LED is turned Off and Reset function of all channel units in latch state according to Alarm setting is executed.

### 8.2. RS485 MODBUS Interface

#### 8.2.1. Setting for communication

- Baud rate : 9600BPS
- Stop bit : 1 Stop
- Parity : Even parity

#### 8.2.2. Setting for RS485 MODBUS communication and Register

- Concentration values for Channel unit (Analog input)

NO	FUNCTION NAME	ADDRESS	OTHER
1	Concentration value for Channel-1 unit	30001	Address increased by 1 at a time per Channel unit.
2	Concentration value for Channel-2 unit	30002	
3	Concentration value for Channel-n unit	30xxx	

[Table 5. Register of concentration values for channel Unit RS485]

- Bit data for Channel unit state ( Reading data for digital input contact)

NO	FUNCTION NAME	ADDRESS	OTHER
Channel-1 unit	Alarm1 state data	10001	8Bit each assigned per 1 Channel unit
	Alarm2 state data	10002	
	Alarm3 state data	10003	
	Breakdown state data	10004	
	Checkup state data	10005	
	Reserve data	10006~10008	
Channel-2 unit	Alarm1 state data	10009	8Bit each assigned per 1 Channel unit
	Alarm2 state data	10010	
	Alarm3 state data	10011	
	Breakdown state data	10012	
	Checkup state data	10013	
	Reserve data	10014~10016	
Channel-n unit	State data	10001+((n-1)*8) ~ 10001+(((n-1)*8)+8)	

[Table 6. Register of channel Unit RS485 state]

### 9.1. Power ON

- Check wire connection of operation power supply, wire connection with detection unit, wire connection between alarm unit and concentration display unit, etc.
- Turn ON the power supply switch after checking input power supply.
- Check lighting of Power LED for alarm unit and concentration display unit.
- Check display of "SELF" in FND for concentration display unit.

- When power supply for Channel unit is turned ON, "SELF" in FND for concentration display unit blinks for 15 Sec, and immediately becomes measuring state when Warming-Up is finished.
- If abnormality occurs in equipment and detection unit at this time, breakdown alarm occurs

### 9.2. Gas Measuring Mode

- If there is no abnormality in SELF TEST after Power On, the following gas measuring state is automatically entered into.

- Gas concentration values received from the detector are displayed in FND Digital display as figures.
- The gas concentration is also displayed by 3 Color Bar graphic LED, in green for the concentrations of less than 1st Alarm , in orange for the concentrations of more than 1st Alarm but less than 2nd Alarm, and in red for the concentrations of more than 2nd Alarm.
- 3-stage Alarm setting values are constantly displayed by 3 Color bar graphic LED, in green for 1st Alarm values, in orange for 2nd Alarm values, and in red for 3rd Alarm values.

- When the detector is not connected or has abnormalities, the text of "Undr" is displayed by blinking at an interval of about 0.5sec.
- Trouble LED lamp is lighted.
- The circular LED at the bottommost among 3 Color bar graphic LED's is lighted in red

- When the current value inputted from the detector is inputted as a current value of more than the set High Scale value by 10%, the text of "Ouer" is displayed by blinking at an interval of 0.5 sec.
- The circular LED at the topmost among 3 Color bar graphic LED's is lighted in red..
- When the gas concentration value is recognized as being more than the Alarm setting value, Alarm function is operated as the relevant Alarm function counts the Alarm maintenance time to find it to be more than the Alarm maintenance time.
- While the Alarm maintenance time is being counted, Alarm LED Lamp blinks at an interval of 0.5sec, and lighted when it becomes more than the Alarm maintenance time.
- Alarm relay is turned ON when it becomes more than the Alarm maintenance time.
- When Alarm latch type is in "on" mode, Alarm state and gas concentration value are maintained at the maximum value upon operation of Alarm function, is not cleared even when the gas concentration is lowered below the Alarm value, in which case, it must be cleared by using "Reset" key.
- When the Alarm latch type is in "off" mode, Alarm function is automatically cleared depending on gas concentrations

### 9.3. Test Mode

■ If there is no abnormality in SELF TEST after Power On, the following gas measuring state is automatically entered into.

	<ul style="list-style-type: none"> <li>- When "Test" key is pushed for more than 2sec in the display state of gas concentration, Test mode is entered into.</li> <li>- When 30 min is passed after the last key operation in Test mode, the display state of gas concentration is automatically entered into.</li> </ul>
	<ul style="list-style-type: none"> <li>- Upon entering in Test mode, the displayed figure for gas concentration is displayed by blinking, where this function allows test in Channel unit without injection of sensor gas in the detector. When the user pushes "▲" key or "▼" key, an arbitrary concentration value for gas concentration can be set, while Alarm function is normally operated with the concentration value designated by sec, FND/LED/Bar LED test function is entered into.</li> <li>- When "Reset" key is pushed, the concentration display mode is returned to.</li> </ul>
	<ul style="list-style-type: none"> <li>- FND/LED/Bar LED Test mode where FND figure of 4 digits and the entire display (8888) are displayed at an interval of 0.5sec, with the 4-digit figure displaying the setting values for PC Add(SW1) and CH CNT(SW2) of Common unit.</li> <li>- 3 Color bar graphic LED displays green, orange and red colors alternately at an interval of 0.5sec with each function LED blinking at an interval of 0.5sec.</li> <li>- When "Func" key is pushed, the mode for checking Channel unit with normal operation of Common unit and communication is entered into.</li> <li>- When "Reset" key is pushed, the concentration display mode is returned to.</li> </ul>
	<ul style="list-style-type: none"> <li>- Mode for checking of Channel unit with normal operation of Common unit and communication, where the No. of channel unit with normal communication being realized is sequentially displayed at an interval of 0.5sec.</li> <li>- If there is a No. for Channel unit where all of the number of channel units set in common unit is not displayed but omitted, then it becomes the channel unit without communication.</li> <li>- When "Func" key is pushed, Test function for gas concentration is returned to.</li> <li>- When "Reset" key is pushed, the concentration display mode is returned to.</li> </ul>

### 9.4. Checkup mode (Stand-by Mode)

	<ul style="list-style-type: none"> <li>- When "▼(Standby)" key of channel unit is pushed for more than 2sec in the display state for gas concentration, checkup mode is entered into.</li> <li>- In the checkup mode, the checkup mode is cleared and the display state for gas concentration is returned to when "▼(Standby)" key is surely pushed in channel unit,</li> <li>- The function where STD-BY LED blinks inn checkup mode, and contact output of Trouble/Alarm relay for Common unit and Channel unit Trouble/Alarm relay does not operate with all remaining functions in operation.</li> <li>- When "▼(Standby)" is pushed, the concentration display mode is returned to.</li> </ul>
--	---

### 9.5. Setting for operation

#### 9.5.1. PROGRAM MODE





	<ul style="list-style-type: none"> <li>- When "▲", "▼" keys are simultaneously pushed in the display state for gas concentration, the setting function for program data is entered into.</li> <li>- In the program setting function, the display state for gas concentration is automatically returned to when 10 sec passed after the last key operation in the program setting function.</li> </ul>
	<ul style="list-style-type: none"> <li>- The message for setting of decimal point as the 1st function of setting function for program data is displayed as "dP-S".</li> <li>- When "Func" key is pushed, the setting function for decimal point is entered into.</li> <li>- When "Reset" key is pushed, the concentration display mode is returned to.</li> </ul>
	<ul style="list-style-type: none"> <li>- Decimal point is used when there is a need to change according to measuring range. When position of the decimal point is set, the position of the decimal point is changed in 3 ways as shown on the left whenever "▲" key or "▼" key is pushed.</li> <li>- If "FUNC" key is pushed when the desired position of decimal point is displayed, the decimal point position is set and the next item is entered into.</li> <li>- When "Reset" key is pushed, the concentration display mode is returned to.</li> </ul>
	<ul style="list-style-type: none"> <li>- The message for setting function of High scale as a function for setting the maximum value of gas concentration display is displayed as "H-SL".</li> <li>- When "Func" key is pushed, the setting function for High scale is entered into.</li> <li>- When "Reset" key is pushed, the concentration display mode is returned to.</li> <li>- High scale value is set for the range specified by domestic regulations upon product shipment.</li> </ul>
	<ul style="list-style-type: none"> <li>- The setting value for High scale can be changed according to measuring range, and the Scale value is increased or decreased whenever "▲" key or "▼" key is pushed.</li> <li>- If "FUNC" key is pushed when the desired High scale value is displayed, the High scale value is set, and the next item is entered into.</li> <li>- When "Reset" key is pushed, the concentration display mode is returned to.</li> <li>- The present setting mode shall be set for the same measuring range as the detection unit upon factory shipment. Ex) When Range setting was made to be 100 Upon inputting of 4 mA.DC ..... 0 Display Upon inputting of 20 mA. DC ..... 100 Display</li> </ul>

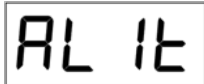

SAd	<ul style="list-style-type: none"> <li>- The message for setting function of SAD values as a function to compensated for errors in measured values occurring in detection unit is displayed as "SAd".</li> <li>- When "Func" key is pushed, the setting function for SAD value is entered into.</li> <li>- When "Reset" key is pushed, the concentration display mode is entered into.</li> </ul>
<div style="border: 1px solid black; padding: 2px; display: inline-block;">0</div> <div style="border: 1px solid black; padding: 2px; display: inline-block;">- 1</div>	<ul style="list-style-type: none"> <li>- Function for setting of SAD value, and SAD value is increased or decreased whenever "▲" key or "▼" key is pushed.</li> <li>- If "FUNC" key is pushed when the desired SAD value is displayed, SAD value is set and the next item is entered into.</li> <li>- When "Reset" key is pushed, the concentration display mode is returned to.</li> </ul> <p>Ex) When SAD was set as 2 :When the output error in detector is -2, Display calibrates the SAD setting value 2 and displays it as 0 although actual Display should indicate -2.</p>
CHno	<ul style="list-style-type: none"> <li>- The message for setting function of Channel number as a function for setting the recognition No. for Channel unit is displayed as "CHno".</li> <li>- When "Func" key is pushed, the setting function for Channel number is entered into.</li> <li>- When "Reset" key is pushed, the concentration display mode is returned to.</li> </ul>
<div style="border: 1px solid black; padding: 2px; display: inline-block;">1</div>	<ul style="list-style-type: none"> <li>- Channel No. is a mode where Channel unit address is inputted to allow checking of operation situations for each channel in Common unit, and Address NO. value is increased or decreased whenever "▲" key or "▼" key is pushed. .</li> <li>- If "FUNC" key is pushed when the desired Address NO is displayed, the Address NO value is set and Alarm reset type function as the next item is entered into..</li> <li>- When "Reset" key is pushed, the concentration display mode is returned to.</li> </ul> <p>Note 1) Unless the Channel No.is inputted, communication between Channel unit and common unit does not occur.</p> <p>Note2) For Channel No, mutually different Nos. must be inputted.</p>

### 9.6. ALARM Mode

- When "Func" key is pushed for more than 2 sec in the display state of gas concentration, the setting function for alarm value data is entered into.
- When 10 sec passes after the last key operation in the setting function for alarm value, the display state of gas concentration is automatically returned to.

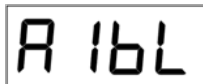

LACH	<ul style="list-style-type: none"> <li>- The message for setting function of Alarm latch type as a function for setting of Alarm latch type is displayed as "LACH".</li> <li>- When "Reset" key is pushed, the concentration display mode is returned to.</li> </ul>
<div style="border: 1px solid black; padding: 2px; display: inline-block;">on</div> <div style="border: 1px solid black; padding: 2px; display: inline-block;">off</div>	<ul style="list-style-type: none"> <li>- Mode for change of Alarm reset type, and "on" and "oFF" modes are changed whenever "▲" key or "▼" key is pushed .</li> <li>- If "FUNC" key is pushed when the desired Alarm latch type is displayed. the Alarm latch type is set and the next item is entered into.</li> <li>- Alarm latch type has 2 types of "on" and "oFF" OFF where Alarm is automatically Reset in OFF mode, while Alarm is Reset in on mode when the user surely clears by pushing Reset key.</li> </ul>
AL-1	<ul style="list-style-type: none"> <li>- The message for setting function of Alarm 1 value as a function for setting of Alarm1 value is displayed as "AL-1".</li> <li>- When "Func" key is pushed, the setting function for Alarm1 value is entered into.</li> <li>- When "RESET" key is pushed, the concentration display mode is returned to.</li> <li>- Alarm level is set for the concentration specified by domestic regulations upon product shipment.</li> </ul>
<div style="border: 1px solid black; padding: 2px; display: inline-block;">1</div> <div style="text-align: center;">▼▲ Full Range</div>	<ul style="list-style-type: none"> <li>- Function for change of Alarm1 setting value, where the maximum value is possible up to the High scale value, and the Alarm1 value is increased or decreased "whenever "▲" key or "▼" key is pushed.</li> <li>- If "FUNC" key is pushed when the desired Alarm1 value is displayed, the Alarm1 value is set and the next item is entered into.</li> <li>- When "Reset" key is pushed, the concentration display mode is returned to.</li> </ul>
<div style="border: 1px solid black; padding: 2px; display: inline-block;">1H</div> <div style="border: 1px solid black; padding: 2px; display: inline-block;">1L</div>	<ul style="list-style-type: none"> <li>- Mode for setting of the operation direction of Alarm1, "1H " or "1L " is displayed whenever "▲" key or "▼" key is pushed.</li> <li>- "1H " mode is the mode operating when it is larger than or the same as Alarm1 setting value, while "1L " mode is the mode when it is smaller than or the same as Alarm1 setting value.</li> <li>- If "FUNC" key is pushed when the desired mode is displayed, the mode is set and the next item is entered into.</li> <li>- When "Reset" key is pushed, the concentration display mode is returned to.</li> <li>- Alarm type is set for flammability: 1H and 2H and 3H / oxygen: 3H and 2L and 1L / toxicity: 1H and 2H and 3H Type upon factory shipment.</li> </ul>

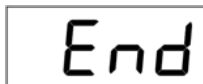

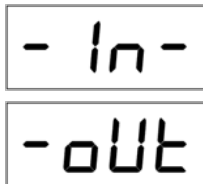

	<ul style="list-style-type: none"> <li>- Mode for setting of Dead band value with operation of Alarm1, and the value is increased or decreased whenever "▲" key or "▼" key is pushed.</li> <li>- Function where Alarm1 operates above Alarm value plus Dead band value when the Alarm1 is in "1H" mode while Alarm1 is cleared below Alarm value minus Dead band value.</li> <li>- Function where Alarm1 operates below Alarm value minus Dead band value when Alarm1 is in "1L" mode while Alarm1 is cleared above Alarm 1 value plus Dead band value.</li> <li>- If "FUNC" key is pushed when the desired Alarm1 Dead band value is displayed, the value is set and the next item is entered into.</li> <li>- When "Reset" key is pushed, the concentration display mode is returned to.</li> <li>- In this function, Alarm continues On/Off when the concentration value reaches near the Alarm setting value. It is the function of giving hysteresis value to remove such phenomenon, and the value is set for 0 upon factory shipment.</li> <li>Ex) When the alarm setting value is 20%LEL / Dead band: 2%LEL, the alarm occurs at 22% LEL based on 20%LEL, and is cleared at 18%LEL.</li> </ul>
	<ul style="list-style-type: none"> <li>- The message for setting function of Alarm1 delay time as a function for setting of Alarm1 delay time is displayed as "AL1t".</li> <li>- When "Func" key is pushed, the setting function for Alarm1 delay time is entered into.</li> <li>- When "RESET" key is pushed, the concentration display mode is returned to.</li> </ul>
	<ul style="list-style-type: none"> <li>- Function to prevent occurrence of instantaneous malfunction of detector due to effects of external impact and noise rather than normal operation, and Alarm1 delay time is increased or decreased by the unit of sec whenever "▲" key or "▼" key is pushed.</li> <li>- If "FUNC" key is pushed when the desired Alarm1 delay time is displayed, the Alarm1 delay time is set and the next item is entered into.</li> <li>Ex) When alarm setting value: 20% LEL / Delay time: 5 Sec, alarm occurs based on 20%LEL when the measured value above the alarm setting value for more than 5sec, while alarm does not occur when it falls below the alarm setting value within 5 Sec.</li> </ul>
	<ul style="list-style-type: none"> <li>- The message for setting function of Alarm1 contact output as a function for setting of Alarm1 contact output is displayed as "A1rL".</li> <li>- When "RESET" key is pushed, the concentration display mode is returned to.</li> </ul>
	<ul style="list-style-type: none"> <li>- Mode for change of Alarm1 contact output, and "on" and "oFF" modes are changed whenever "▲" key or "▼" key is pushed.</li> <li>- If "FUNC" key is pushed when the desired Alarm1 contact output mode is displayed, the Alarm1 contact output mode is set and the next item is entered into.</li> <li>- When "RESET" key is pushed, the concentration display mode is returned to.</li> <li>- Alarm1 contact output mode has 2 modes of "on" and "oFF", where Alarm1 contact output does not operate in oFF mode while Alarm1 contact output operates in on mode.</li> </ul>

	<ul style="list-style-type: none"> <li>- The message for setting function of Alarm1 blink output as a function for setting the function of ON/OFF of Alarm1 contact output at an interval of 1 sec while buzzer is operating is displayed as "A1bL".</li> <li>- When "Func" key is pushed, the setting function for Alarm1 blink output is entered into.</li> <li>- When "RESET" key is pushed, the concentration display mode is returned to.</li> </ul>
	<ul style="list-style-type: none"> <li>- Mode for change of Alarm1 blink output, "on" and "oFF" modes are changed whenever "▲" key or "▼" key is pushed.</li> <li>- If "FUNC" key is pushed when the desired Alarm1 blink outmode is displayed, the Alarm1 blink output mode is set and the next item is entered into.</li> <li>- When "RESET" key is pushed, the concentration display mode is returned to.</li> <li>- Alarm1 blink output mode has 2 types of "on" and "oFF", where Alarm1 blink output does not operate in oFF mode while Alarm1 blink output is operated in on mode. (However, it operates when the Alarm1 contact output mode is on.</li> <li>- Both the 2nd alarm (Alarm2) and the 3rd alarm (Alarm3) have the same menu structure.</li> </ul>
	<ul style="list-style-type: none"> <li>- The message informing completion of the setting function is displayed as "End" for 2 sec, and the display state of gas concentration is returned to.</li> </ul>

■ Both the 2nd alarm and the 3rd alarm have the same menu structure.

### 9.7. Maintenance Mode

	<ul style="list-style-type: none"> <li>- If "TEST" and "RESET" keys are simultaneously pushed when "SELF" is blinking after power supply ON, the setting function for Maintenance is entered into.</li> <li>- When "Reset" key is surely pushed in Maintenance mode, the display state for gas concentration is returned to.</li> </ul>
	<ul style="list-style-type: none"> <li>- Mode for selection of functions setting current input value and output value as the reference for Alarm Channel unit, and "-In-" or "-oUt" is displayed whenever "▲" key or "▼" key is pushed.</li> <li>- If "FUNC" key is pushed when the desired mode is displayed, the relevant mode is entered into.</li> <li>- When "-In-" is selected, it is the mode for setting of current input values, while it is the mode for setting of current output values when "-oUt" is selected.</li> <li>- When "Reset" key is pushed, the concentration display mode is returned to.</li> </ul>
	<ul style="list-style-type: none"> <li>- Mode for setting by inputting the current of 20mA in the case of having selected "-In-", and the message is displayed as "1A20".</li> <li>- When "Func" key is pushed, the function with the current input value being displayed as figures is entered into.</li> <li>- When "Reset" key is pushed, the concentration display mode is returned to.</li> </ul>

	<ul style="list-style-type: none"> <li>- Mode where the values converted in processor by inputting 20mA current in (mA) terminal are displayed as figures.</li> <li>- If "Func" key is pushed when the displayed figure is stable, the current input value is set and the next item is entered into.</li> <li>- When "Reset" key is pushed, the concentration display mode is returned to.</li> </ul>
	<ul style="list-style-type: none"> <li>- Mode for setting output current of 4mA when "-Out" was selected the next mode for input current mode, and the message is displayed as "A-04".</li> <li>- If "Func" key is pushed when the ammeter accurately displays 4mA by pushing "▲" key or "▼" key while watching the ammeter after connecting the ammeter to 4~20mA output terminal, the output current value is set and the next item is entered into.</li> <li>- When "Reset" key is pushed, the concentration display mode is returned to.</li> </ul>
	<ul style="list-style-type: none"> <li>- Mode setting for 20mA output current with the message being displayed as "A-20".</li> <li>- If "Func" is pushed when the ammeter accurately displays 20mA by pushing "▲" key or "▼" key while watching the ammeter after connecting the ammeter to 4~20mA output terminal, the output current value is set and the next item is entered into.</li> <li>- When "Reset" key is pushed, the concentration display mode is returned to.</li> </ul>
	<ul style="list-style-type: none"> <li>- The message informing completion of the setting function is displayed as "End" for 2 sec, and the display state of gas concentration is returned to.</li> </ul>

### 10.1. Basic configuration

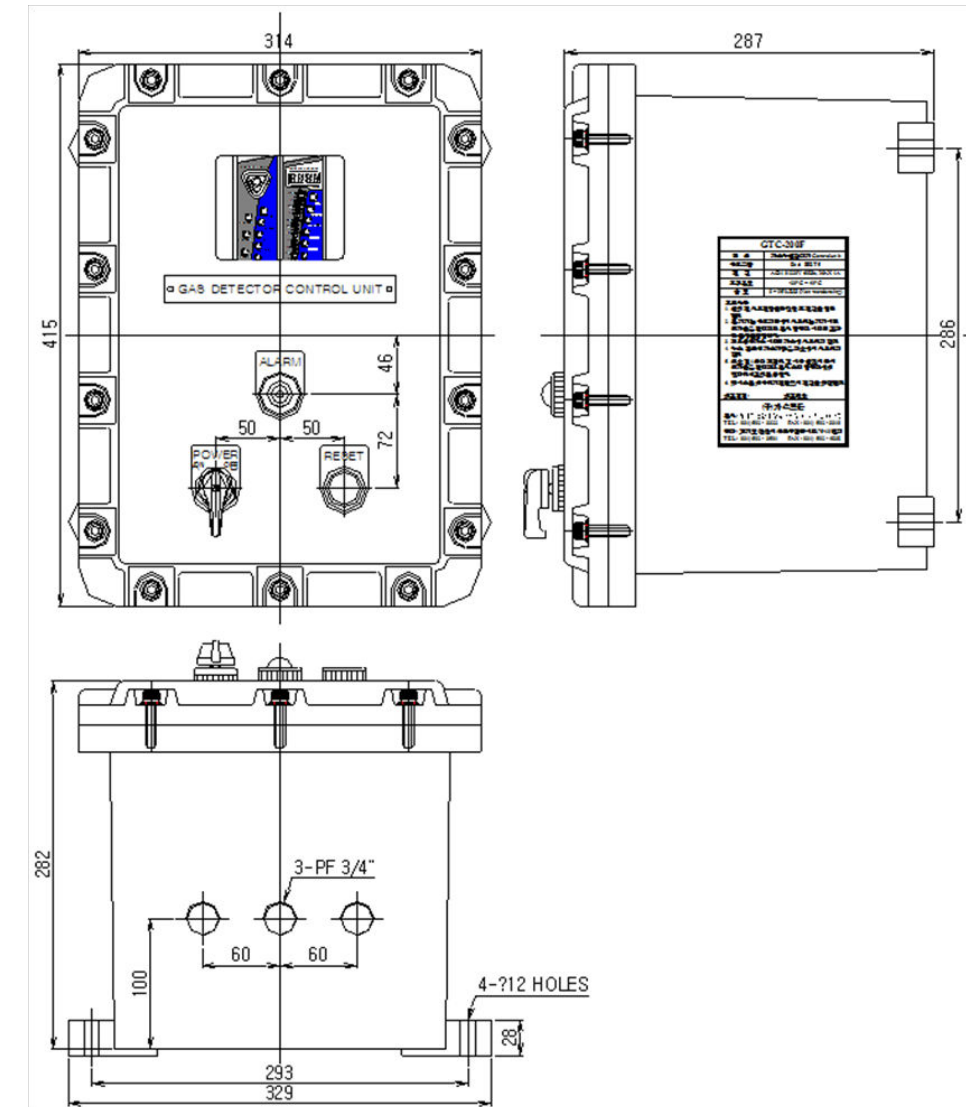

[Figure 10. Outline drawing for basic product]



## 10.2. Power unit

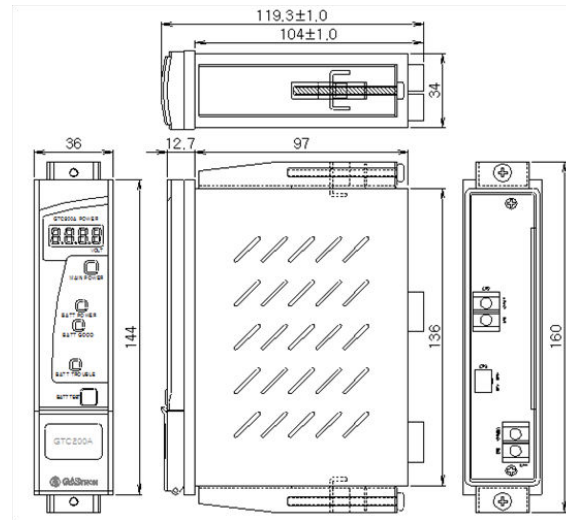

[Figure 11. Outline drawing for Channel Unit]

## 10.3. Common Unit

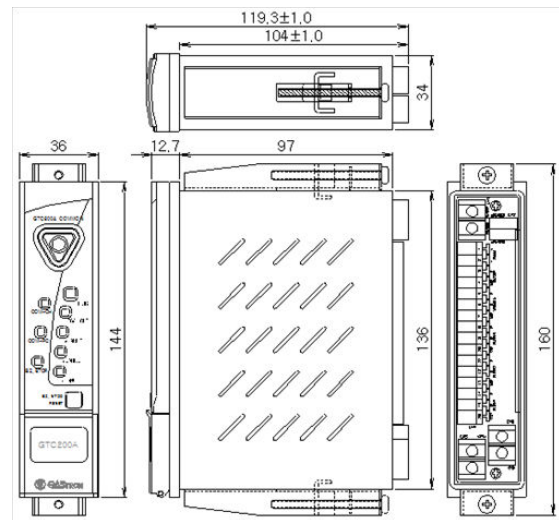

[Figure 12. Outline drawing for Common Unit]

## 10.4. Channel Unit

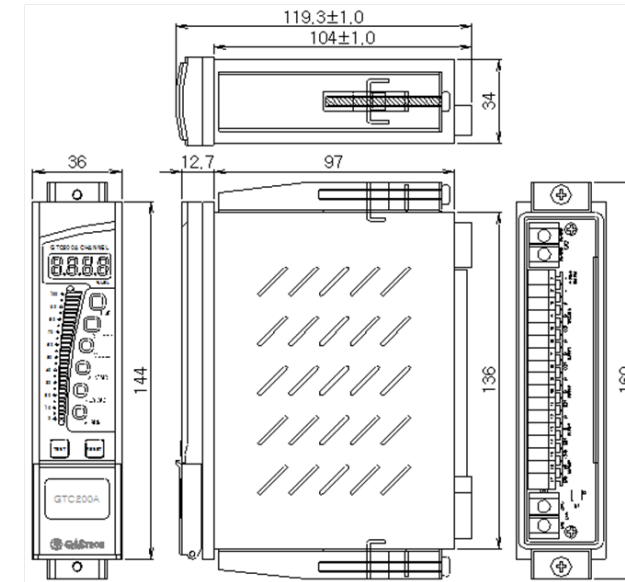

[Figure 13. Outline drawing for Channel Unit]

### 11.1. Selection of installation place (Data from Occupational Safety and Health regulations)

The place for installation of gas leakage detection alarm is as follows.

- Surroundings of chemical equipment and accessory equipment with a risk of gas leakage such as compressor, valve, reactor, piping connection part, etc. that are installed inside and outside buildings to deal with flammable and toxic substances
- Place with easy dwelling of gas around manufacturing equipment with ignition sources such as heating furnace, etc.
- Around the connecting part for filling of flammable and toxic substances
- Power substation, power distribution panel room, control room, etc. positioned within explosion-proof area
- Other places with especially easy dwelling of gas

### 11.2. Selection of installation place(Data from regulations on safety management for high-pressure gas)

Gas detector for has leakage detection alarm should be installed as close as possible to leakage parts with a risk of gas leakage. However, for the places with likelihood of dwelling of gas leaked from surroundings although direct gas leakage is not expected, installation should be implemented at spots such as No.1 of the following list.

- Gas leakage detection alarm installed outside a building shall be installed at a spot with dwelling likelihood of gas by considering wind direction, wind velocity ,specific gravity of gas, etc.
- Gas leakage detection alarm installed inside a building should be installed in the lower part inside the building when specific gravity of the detection target gas is larger than that of air, while it should be installed near ventilation port of the building or in the upper part inside the building when it is lighter than air.
- Alarm of Gas leakage detection alarm should be installed at a place with installation of Gas detector and a place of constant residence of workers

### 11.3. Notes upon installation

Positions that can be an electric obstacle such as rain water, etc. should be avoided for installation, and installation at a place for easy operation is recommended since periodic maintenance and repair are. Since the places with vibration or impact can affect output values, places with vibration or impact shall be avoided for installation, and installation shall be such that the sensor unit is facing the direction of gravity.

- The present instrument shall belong to the GROUP aimed at gas, vapor of general business places and chemical plants as a pressure-resistant, explosion-proof structure, and can be used for dangerous places of ZONE 1(ONE)-type 1 and ZONE 2(TWO)-type 2.
- Allowed temperatures belong to less than 85°C corresponding to T6.
- It shall be used in the range of -20°C ~ 40°C for ambient temperature

- Installation altitude: Less than 1,000M above sea level
- Relative humidity: 5% ~ 99%
- Installation place: Outdoors and indoors
- Explosion and ignition level of target gas or vapor: Ex d IIC T6Positions that can be an electric obstacle
- When explosion-proof cable gland is used in cable lead-in port or metal cable conduit wiring construction is conducted, cable conduit should be sealed to prevent moving of gas, etc. through cable conduit within 50mm or propagation of flames upon explosion.
- Upon connection of the present instrument and cable conduit, more than 5 threads should be made to be coupled.
- Conduct operation under the conditions meeting other [Standards related to selection, installation and repair, etc. of explosion-proof structure, electricity, machine, apparatus, wiring, etc. of business place].
- For all materials used for cable lead-in such as CABLE GLAND and SEALING FITTING, etc. as well as materials used for finishing of the unused lead-in unit, make sure to sue products having passed qualification!

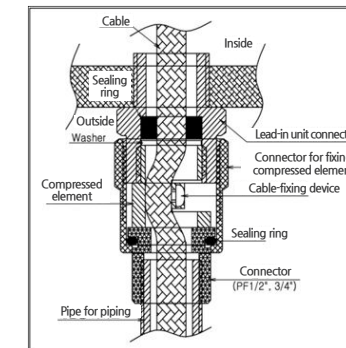

[Figure 14. Pressure-resistant packing]

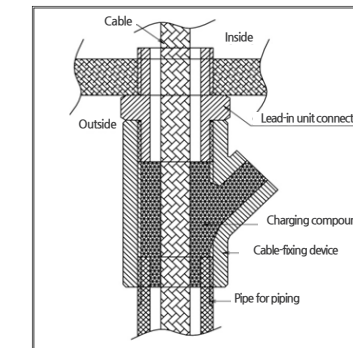

[Figure 15. Y Sealing Compound]

VERSION	CONTENTS	DATE
0.0	Manual initially revised	2011. 06. 27
1.0	Font changed	2016. 10. 28
2.0	Installation regulation for Cable Entry in explosion-proof instrument changed 45cm → 50mm	2017. 01. 20