

# GASTRON

Headquarters / Engineering research laboratory :  
23 Gunpo Advanced Industry 1-ro(Bugok-dong), Gunpo-si, Gyeonggi-do  
Tel +82-31-490-0800 Fax +82-31-490-0801

Yeongnam business office / Plant :  
55 Gonghangap-gil, 85beon-gil, Gangseogu, Busan Metropolitan City  
Tel +51-973-8518 Fax +51-973-8519

E-mail : info@gastron.com

www.gastron.com

# GTD-5000

## Instruction Manual



# GASTRON

# GASTRON

Read in detail for correct use.

# Gas & Flame Detection System

**GASTRON**



When abnormalities occur after purchasing the product,  
please contact the following address.

- Address : 23 Gunpo Advanced Industry 1-ro,  
Gunpo-si, Gyeonggi-do
- Tel : 031-490-0800
- Fax : 031-490-0801
- URL : www.gastron.com
- e-mail : info@gastron.com

## We sincerely thank you for purchasing the product of Gastron Co. Ltd.

Our Gastron Co.Ltd. is a company specialized in Gas detector and Gas Monitoring System, being recognized by many consumers due to the best quality and use convenience. We always enable you consumers to find desired products nearby and are ceaselessly studying and striving for development of Gas detectors satisfying customers. From now on, solve all anguishes concerning Gas detector with the products of Gastron Co. Ltd, We Gastron Co. will take a responsibility and give you satisfaction.

In the present instruction manual, operation method for Gas detector as well as simple methods for maintenance and repair, etc. are recorded. If you read it in detail and keep it well, for reference when you have questions, then it will give you much help.

- For accurate operation of Gas detector, check up and calibrate for more than once in every 6 months.  
( \* See No. 13 of KOSHA GUIDE : P-135-2013 / 8.3 paragraph on qualification and calibration)
- For accurate operation of Gas detector, checkup and calibration with calibration gas before measurement is recommended.
- When not calibrated, it may cause malfunction of the equipment due to problems resulting from Sensor aging.
- When the present instrument should be dismantled, those with professional skills for Gas detector should conduct the operation.
- For power supply cable, wire specifications should be determined by referring to the item of "Length of installed cable".
- For the contents on checkup and calibration of Gas detector, please use our company's engineering department , e-mail, or web site.

The present product and the product manual can be changed without advance notice for performance improvement and use convenience of the product.

\* KOSHA GUIDE : P-135/6-2018

Calibration should be executed at the periods required by the manufacturer, and should be executed every quarter unless there are separate calibration periods.

<b>1. Overview</b> .....	6	<b>7. System Mode</b> .....	22
<b>2. Configuration</b> .....	6	7.1. Mode Configuration .....	22
<b>3. Specification</b> .....	7	7.2. Detailed Menu Configuration .....	22
3.1. Basic Specifications .....	7	7.3. Configuration Mode .....	24
3.2. Mechanical Specifications .....	7	7.4. Program setting .....	26
3.3. Electrical Specifications (Standard Type) .....	8	7.5. Zero Calibration .....	27
3.4. Environmental Specifications .....	9	7.6. Span Calibration .....	28
<b>4. Name and Description of Each Part</b> .....	10	7.7. Alarm mode .....	29
4.1. Components .....	10	<b>8. Troubleshooting</b> .....	33
4.2. Front Display Configuration .....	12	8.1. Fault List .....	33
<b>5. Installation</b> .....	13	8.2. Warning List .....	33
5.1. Detachment of Housing Cover .....	13	8.3. Recovery List .....	34
5.2. Terminal PCB Configuration .....	14	<b>9. Interface Configuration</b> .....	35
5.3. Power and 4-20mA Signal Configuration .....	14	9.1. MODBUS RS485 .....	35
5.3.1. Power and Signal Terminal Configuration .....	14	9.1.1. Interface setting .....	35
5.3.2. Power and 4~ 20mA Source Configuration .....	15	9.1.2. MODBUS RS485 Register map .....	35
5.3.3. Power and 4~ 20mA Sink Configuration .....	15	9.2. MODBUS/TCP Interface .....	36
5.3.4. Power and 4~20mA 3Wire Sink Configuration .....	15	9.2.1. Interface setting .....	36
5.4. Alarm and RS485 Signal Configuration .....	16	9.2.2. MODBUS TCP/IP Register map .....	36
5.4.1. RS485& Relay Terminal Configuration .....	16	<b>10. Drawings and Dimensions</b> .....	39
5.4.2. Trouble Relay Output Configuration .....	16	10.1. GTD-5000 Standard Type .....	39
5.4.3. Alarm1 Relay Output Configuration .....	16	10.1. GTD-5000 & PY-1000 .....	40
5.4.4. Alarm2 Relay Output Configuration .....	16	10.2. GTD-5000 & PY-2000 .....	41
5.4.5. RS-485 Terminal Configuration .....	17	<b>11. Precautions before Installation</b> .....	42
5.5. Ethernet Signal Configuration .....	17	11.1. Selecting a Place for Installation (Occupation Safety and Health Act Data) .....	42
5.6. Pyrolyzer Configuration .....	18	11.2. Selecting a Site for Installation (High-Pressure Gas Safety Control Act Data) .....	42
5.7. Installation Cable Length .....	19	11.3. Precautions during Installation .....	42
<b>6. Operation</b> .....	20	11.4. Cable Wiring Work .....	43
6.1. Power On .....	20	<b>12. Revision History</b> .....	44
6.2. Measuring Mode .....	21		
6.3. Internal Mode Configuration .....	21		

GTD-5000 gas detector has been developed to detect gas leaked from industrial sites and various gases generated from factories, gas storages, and manufacturing processes that produce or use flammable gases and to prevent accidents in advance. GTD-5000 gas detector is a sampling type that is installed in areas with gas leak hazards. It continuously monitors gas leak at all time, displays measurements on LCD built in the gas detector, and provides, Analog 4-20 mA standard output, RS-485 network signal, PoE (Power over Ethernet) network signal, and relay contact signal in an event of gas leak alarm. Also, Analog 4-20 mA standard output is possible for connection up to max. 2,500 m of output signal transmission distance between the gas detector and receiver (When CVVS or CVVSB 1.5s sq<sup>†</sup> shield cable is used). RS-485 network signal can be transmitted up to 1,000 m (When a cable designated for RS-485 is used) and PoE (Power over Ethernet) can be transmitted up to 100 m.

## 2. Configuration

GTD-5000 case is made of steel. This product can be installed in areas with leak hazards of all toxic and flammable gases. 4-Digit LCD built in the gas detector displays gas leak status at installed site. Internal configuration consists of display part that shows measurements, main control part that measures and controls gas concentration and flow rate, and terminal part that output current output (Analog 4-20 mA), RS-485 network signal, PoE (Power over Ethernet) network signal, or Alarm signal. Sensor is a cartridge type that can be detached and it is designed to be easily exchanged by the user.

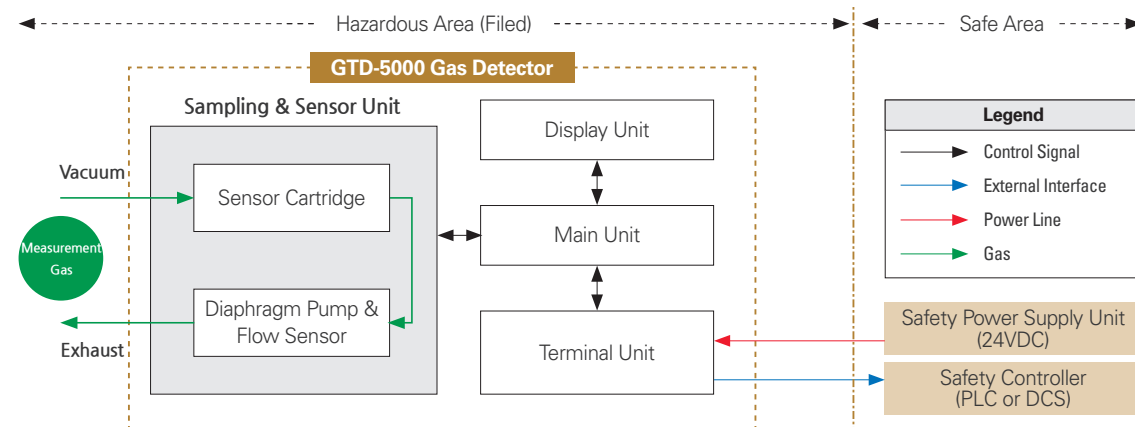

[Figure 1. GTD-5000 Overview]

### 3.1. Basic Specifications

ITEMS	SPECIFICATION	
Measuring Type	Auto Sampling type	
Measuring Type	Flexible Numeric Display LED	
Measuring Method	- Electrochemical / Cartridge - Catalytic / Cartridge - Semiconductor / Cartridge - Photoionization detector(PID) / Cartridge	
Detectible Gas	Flammable gas, Toxic gas, Oxygen (Note1)	
Measuring Range	Capable to display 000.0 ~ 9999 (Note 1)	
Accuracy	≤ ±3% / Full Range	
Zero Drift	≤ 2% / Full Range	
Response Time	Differ by sensor module. Refer to sensor specification or contact us for special gas.	
Pump Type	Diaphragm Pump	
Flow Rate	100 ~ 1,000 ml (Normal 300~500ml / min)	
Approvals Classification	CE ( EN50270:1999 )	
Basic Interface	Analog 4-20mA current interface	
Cartridge Type Option	RS485, PoE Interface, Pyrolyzer option	
Warranty	Transmitter	2Year
	Sensor	1Year

※ Note1. Refer to the measured gas list for measured gases and their ranges. Contact us for special gas.

### 3.2. Mechanical Specifications

ITEMS	SPECIFICATION	
Dimension / mm	Standard Type	70(W) × 144(H) × 160(D)
	PY-1000 M Connecting Model	70(W) × 242.5(H) × 160(D)
	PY-2000 M Connecting Model	70(W) × 267.5(H) × 200(D)
Weight including Sensor	Standard Type	App. 1.75kg
	PY-1000 M Connecting Model	App. 4kg
	PY-2000 M Connecting Model	App. 4.75kg
Mounting type	Wall mount	
Vacuum Tube (Sample gas vent/inlet)	1/4" Teflon Tube	
Body material	Aluminum alloy	

#### 3.3. Electrical Specifications (Standard Type)

ITEMS	SPECIFICATION	
Input Voltage(Standard) ※ Customer supplied PSU must meet requirements IEC1010-1 and CE Marking requirements.	Absolute min:	18V
	Nominal:	24V
	Absolute max:	31V
	Ripple maximum allowed:	1V pk-pk
Input Voltage(PoE option)	48 VDC Power-over-Ethernet (IEEE 802.3af compliant)	
Wattage(Cartridge Type)	Max. wattage:	6.7W @+24 VDC
	Max. current:	280mA @+24 VDC
Wattage(Cartridge and Pyrolyzer)	Max. wattage:	12.5W @+24 VDC
	Max. current:	520mA @+24 VDC
Analog output Current	0-20mA(500 ohms max load) All readings ± 0.2mA Measured-value signal: 4mA(Zero) to 20mA(Full Scale)	
	Fault:	0mA
	0-100% LEL:	4mA - 20mA
	100-109%LEL:	20mA - 21.4mA
	Over 110% LEL: Maintenance:	22mA 3mA
Analog output current ripple & noise max	±20uA	
Relay contact	Alarm1, Alarm2, Fault Relay Rated 1.0 A @ 30VDC or 0.5 A @ 125 VAC	
Wiring requirement	Power	CVVS or CVVSB with shield
	Analog	CVVS or CVVSB with shield
	PoE	CAT5 cable or equivalent RJ45
	RS485	STP(Shielded Twisted Pair)
Cable Connection Length	Analog	2500m
	PoE	100m
	RS485	1000m
EMC Protection:	Complies with EN50270	

#### 3.4. Environmental Specifications

ITEMS	SPECIFICATION	
Operation Temperature	Transmitter	0 to 40 °C
	Sensor	Refer to Sensor Specification
Storage Temperature	Transmitter	-20 to 60 °C
	Sensor	Refer to Sensor Specification
Operation Humidity	Transmitter	5 to 99% RH (Non-condensing)
	Sensor	Refer to Sensor Specification
Pressure Range	90 to 110KPa	
Max. air velocity	6m/s	

### 4.1. Component

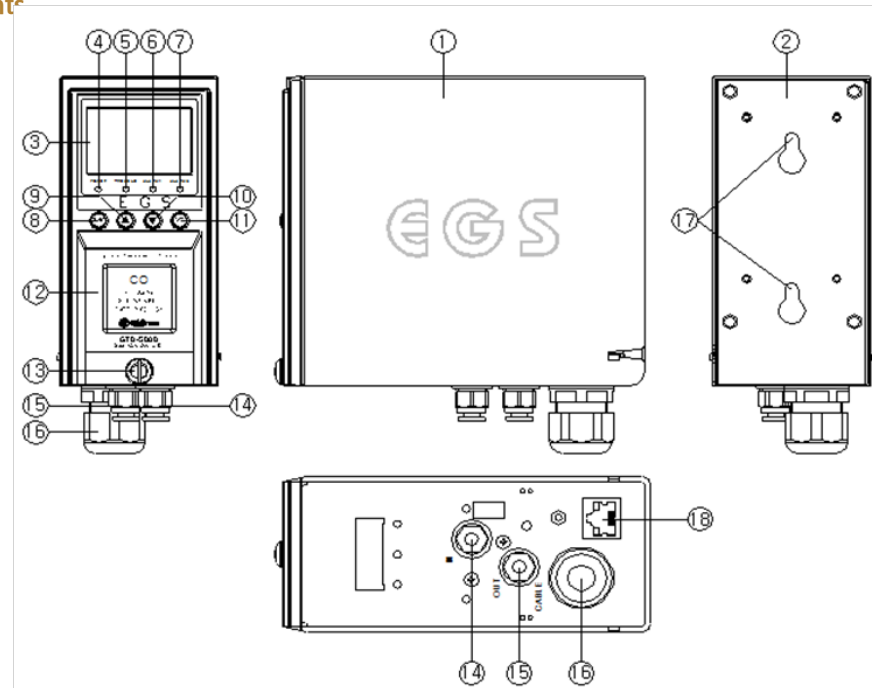

[Figure 2. GTD-5000 Components]

NO	NAME	DESCRIPTIONS
7	Alarm2 LED (Red)	When measured gas concentration exceeds set Alarm2 threshold, the LED lights on and relay contact signal is outputted externally (if it is set). (Alarm2 level can be set arbitrarily in Alarm setting mode.)
8	Function key	It is a key to convert or set a mode in function setting mode. When FUNC key is pressed for 2 sec or longer in measuring mode, it enters function setting menu mode. (Configuration, Program, Calibration, Alarm, Time, etc.)
9	Up key	It is a key to increase a set value in function setting mode.
10	Down key	It is a key to decrease a set value in function setting mode. When down key is pressed for 2 sec longer in measuring mode, it enters test mode (EMS: Emergency Maintenance System). The icon lights on then it flashes. In stand-by mode, pressing down key for 2 sec or longer releases it.
11	Reset key	To change into menu mode or measuring mode from function setting mode, use reset key to return. When reset key is pressed 2 sec or longer in measuring mode, it enters lock mode and the icon lights on. Pressing reset key for 2 sec or longer in lock mode releases it.
12	Sensor cartridge window	It is a window for the users to visually check the sensor cartridge. Target gas name and measuring range, etc. can be confirmed. Sensor cartridge that detects actual gas leak converts the amount of gas leak into data and sends it to the main body. Sensor cartridge saves all data related to the sensor. Changing sensor cartridge automatically recognizes data for operation.
13	Cover fixed screw	It is a screw that fixes the main body case and the front cover case.
14	Sample gas inlet	It is sample gas inlet port. (1/4" Tube).
15	Sample gas outlet	It is sample gas output port. (1/4" Tube).
16	Cable gland	It is power and signal cable inlet.
17	Mount holes	Holes that fix gas detector to wall or other areas.
18	PoE Connector	It is RJ45 Ethernet connector for PoE (Power Over Ethernet) network.

[Table 1. GTD-5000 Component Description]

NO	NAME	DESCRIPTIONS
1	Case cover	Protects PCB Board built in Sensor and Housing from external environmental change and shock.
2	Mounting bracket assembly	It includes mounting hole used for fixing case, cable gland, and gas in/out port, etc.
3	LCD display	It displays gas concentration measurements from the sensor and setting modes during parameter settings in numbers and icons. (Refer to section 4.2 Front LCD display icon for detailed description of icons.)
4	Power LED (Green)	When power is supplied normally, LED lights on.
5	Trouble LED (Yellow)	It lights on when it detects the sensor and flow rate to be fault. It outputs trouble relay contact signal externally.
6	Alarm1 LED (Red)	When measured gas concentration exceeds set Alarm1 threshold, the LED lights on and relay contact signal is outputted externally (if it is set). (Alarm1 level can be set arbitrarily in Alarm setting mode.)

### 4.2. Front Display Configuration

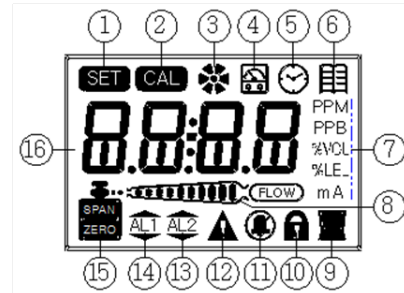

[Figure 2. GTD-5000 Components]

NO	NAME	DESCRIPTIONS
1	Setting Icon	Displayed when performing function that saves setting for a specific operation.
2	Calibration Icon	Displayed when performing calibration.
3	Run Icon	Displayed when pump is in operation.
4	Test Icon	Displayed when gas detector is running in test mode.
5	Time Setting Icon	Displayed when setting gas detector internal time.
6	Display Mode Icon	Displayed when it is in display mode for gas detector internal setting.
7	Measuring Unit Icon	Displays measuring unit (PPM, PPB, %VOL, %LEL, mA)
8	Flow Rate Icon	Displays measured flow rate during normal measuring operation in 10 levels.
9	Network Icon	Displayed during RS485 and PoE MODBUS network.
10	Lock Icon	Displayed when gas detector setting mode is forbidden.
11	Alarm Setting Icon	Displayed when alarm output is forbidden.
12	Fault Icon	Displayed when fault is detected during gas detector self-test.
13	Alarm2 Icon	Displayed during alarm setting or when an alarm is detected.
14	Alarm1 Icon	Displayed during alarm setting or when an alarm is detected.
15	Zero, Span Icon	Displayed during calibration by Zero and Span Modes.
16	Letter Display	Displays measurement and various messages.

[Table 2. Description of Front Display Components]

### 5.1. Detachment of Housing Cover

- <Warning - Do not open when electrical current is flowing>
- Loosen case cover set screw located in the front part of the detector and detach the case cover. Loosen the two main sampling pump assembly set screws and pull to detach. Terminal PCB terminal should appear.

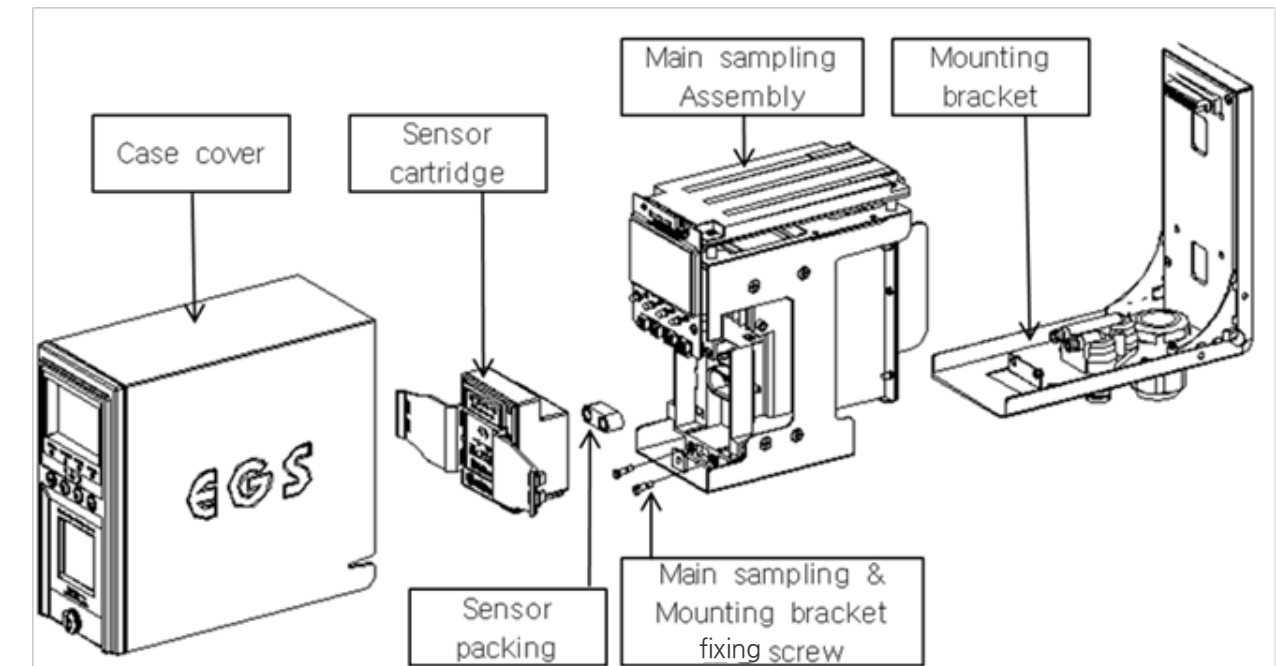

[Figure 4. GTD-5000 Assembly Drawing]

5.2. Terminal PCB Configuration

NO	Type	Description
1	CN4	RJ45 Ethernet Connector(PoE)
2	CN1	Power & Output Signal Terminal
3	J1	Selection Jumper for 4~20 mA Sink or Source
4	CN3	RS485 & Relay Contact Terminal
5	J6, J7	Power Selection Jumper
6	J2	Connector for Pyrolyzer Power Supply
7	J3	Selection Jumper for Alarm2 Relay NO,NC
8	J4	Selection Jumper for Alarm1 Relay NO,NC
9	J5	Selection Jumper for Fault NO,NC

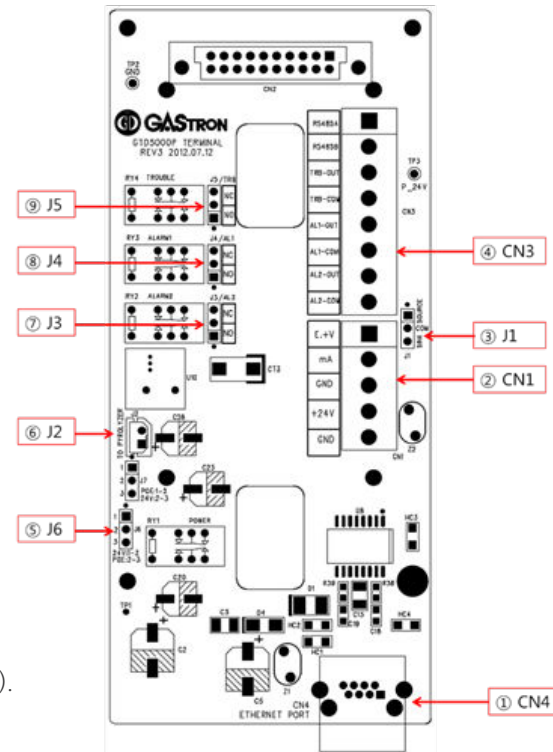

[Figure 5. Terminal PCB Configuration]

5.3. Power and 4-20mA Signal Configuration

- <Warning - Turn off power before connecting power terminal>
- When using DC24V power, connect power to CN1(+24V, GND).
- Shield cables of 1.5 sq and higher must be used.

5.3.1. Power and 4~20 mA Terminal Configuration

NO	Terminal Name	Description
1	E.+V	External power input terminal when J1 sink is selected.
2	mA	4~ 20mA Output Terminal
3	GND	GND for mA and gas detector power
4	+24V	DC +24V for gas detector power
5	GND	Gas detector power GND

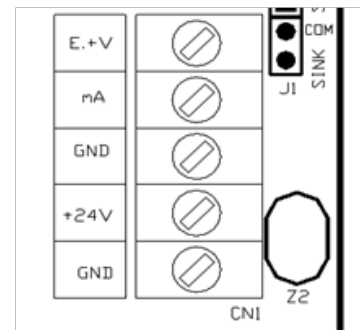

[Figure 6. CN1 Terminal Configuration]

5.3.2. Power and 4~ 20mA Source Configuration

- Connect 4-20 mA signal terminal at PLC side to 'mA' of GTD -5000. GND terminal is used in common with power. Then, connect the Jumper to the SOURCE.

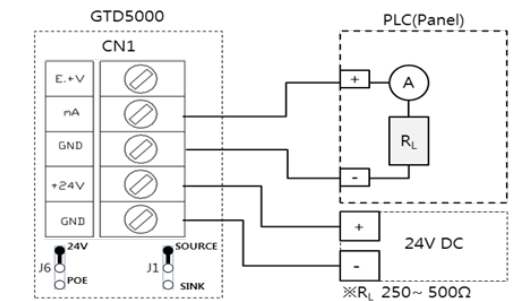

[Figure 7. 4~ 20mA Source Driver Configuration]

5.3.3. Power and 4~ 20mA Sink Configuration

- Connect (+) and (-) terminals for 4-20 mA sink output at PLC side to E.+V terminal and 'mA' terminal, respectively. Then, connect J1 Jumper to Sink side.

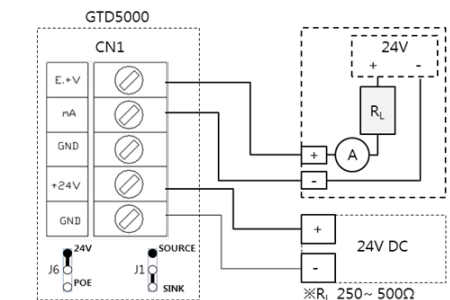

[Figure 8. 4-20mA Sink Configuration]

5.3.4. Power and 4~20mA 3Wire Sink Configuration

- Connect (+) and (-) terminals for 4-20 mA sink output at PLC side to E.+V terminal and power (24V DC) (-) terminal, respectively. Then, connect 'mA' terminal to 'GND' terminal.
- Then, connect J1 Jumper to Sink side.

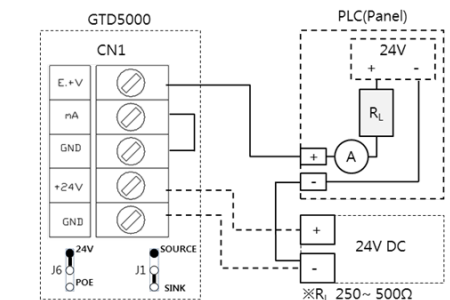

[Figure 9. 4-20mA Sink Configuration]



### 5.4. Alarm and RS485 Signal Configuration

#### 5.4.1. RS485& Relay Terminal Configuration

NO	Terminal Name	Description
1	RS485A	RS485 network A terminal
2	RS485B	RS485 network B terminal
3	TRB-OUT	Trouble relay output terminal
4	TRB-COM	Trouble relay common terminal
5	AL1-OUT	Alarm1 relay output terminal
6	AL1-COM	Alarm1 relay common terminal
7	AL2-OUT	Alarm2 relay output terminal
8	AL2-COM	Alarm2 relay common terminal

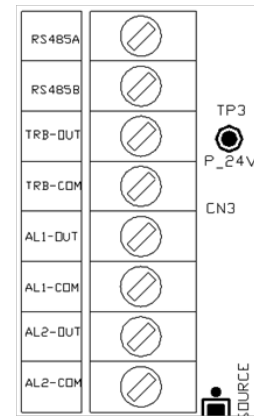

[Figure 10. CN3 Terminal Configuration]

#### 5.4.2. Trouble Relay Output Configuration

Terminal Name	FAULT RELAY CONTACT	JUMPER Setting
TRB-OUT	Normal Close Mode	J5 Jumper NC on
	Normal Open Mode	J5 Jumper NO on
TRB-COM	Common	-

#### 5.4.3. Alarm1 Relay Output Configuration

Terminal Name	FAULT RELAY CONTACT	JUMPER Setting
AL1-OUT	Normal Close Mode	J4 Jumper NC on
	Normal Open Mode	J4 Jumper NO on
AL1-COM	Common	-

#### 5.4.4. Alarm2 Relay Output Configuration

Terminal Name	FAULT RELAY CONTACT	JUMPER Setting
AL2-OUT	Normal Close Mode	J3 Jumper NC on
	Normal Open Mode	J3 Jumper NO on
AL2-COM	Common	-

#### 5.4.5. RS-485 Terminal Configuration

■ Connect RS-485A and RS-485B of CN3 with MODBUS Master terminal as shown below.

Device Terminal Name	Master Terminal Name	Notes
RS485A	'TRXD+' or 'A' or 'P'	
RS485B	'TRXD-' or 'B' or 'N'	

Note 1) Use cable designated for RS-485

Note 2) When there is no RS485 option available for GTD-5000, the following function does not run.

### 5.5. Ethernet Signal Configuration

When using PoE Ethernet, use a device meeting IEEE802.3af standard for PoE Hub and use a cable with shielded CAT5 or higher for configuration.

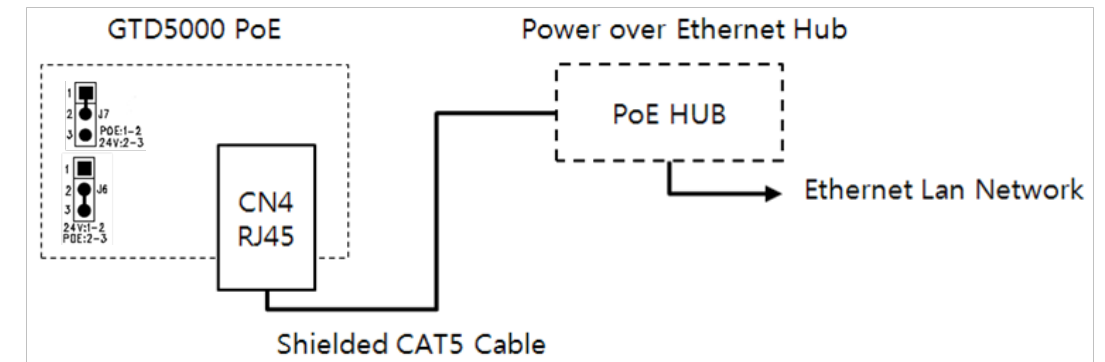

[Figure 11. PoE Configuration]

5.6. Pyrolyzer Configuration

■ When configuring pyrolyzer, J6, J7 Jumper setting must be confirmed based on DC power and PoE power.

MODE	JUMPER SETTING	NOTE
DC Power	Use J6 Jumper 1-2Pin(24V), J7 Jumper 2-3Pin(24V)	
PoE Power	Use J6 Jumper 2-3Pin(PoE), J7 Jumper 1-2Pin(PoE)	

\* DC 24 V is supplied for pyrolyzer power through J2 connector of GTD-5000 Terminal Board.

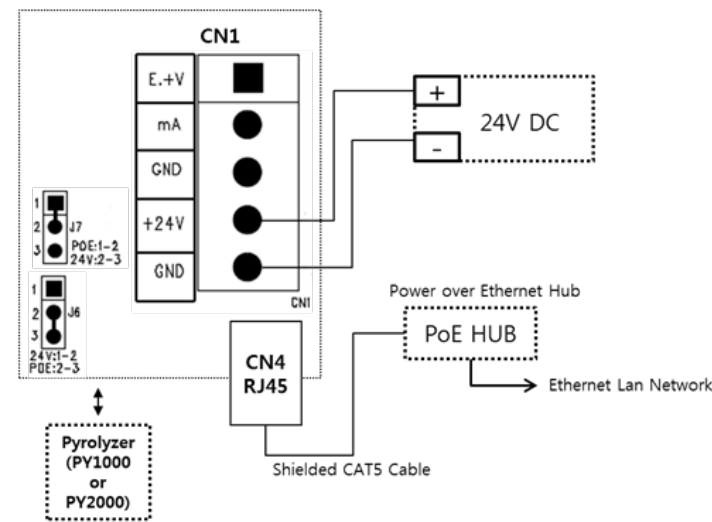

[Figure 12. Pyrolyzer Connection Configuration]

5.7. Installation Cable Length

- The maximum length between GTD -5000 and power supply is decided by wire specification.
- Max. Installation Length =  $V_{MAXDROP} \div I_{MAX} \div WIRER/m \div 2$ 
  - VMAXDROP: Maximum Power Loop Voltage Drop (=Power Supply voltage - min operating voltage)
  - IMAX : Max. Current of GTD -5000
  - WIRER/m: The resistance of the wire (ohms/meter value available in wire manufacturer's specification data sheet)
- Example of installation lengths using 24 V power supply and 16 AWG is as follows.
  - GTD-5000 minimum operating voltage = 18 Vdc
  - VMAXDROP = 24 - 18 = 6V
  - IMAX = 0.52A(520mA)
  - $6 \div 0.52 \div 0.01318 \div 2 = 437.7262m \approx 437m$

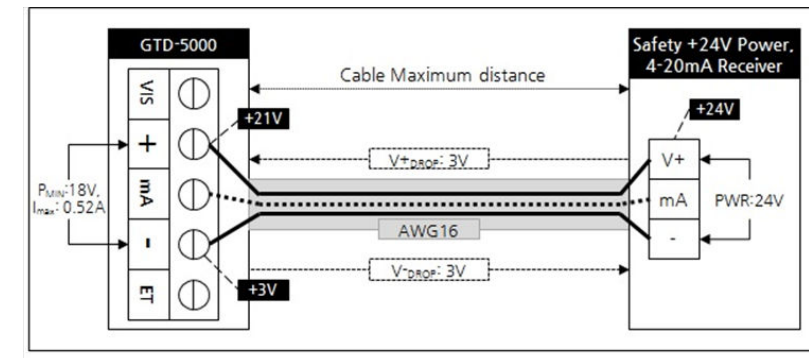









[Figure 13. GTD-5000 Installation Cable Length Calculation]

AWG	mm <sup>2</sup>	COPPER RESISTANCE(ohms/m)	METERS
12	3.31	0.00521	1107
14	2.08	0.00828	696
16	1.31	0.01318	437
18	0.82	0.02095	275
20	0.518	0.0333	173

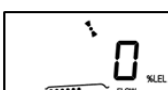

[Table 3. GTD-5000 Power Cable Installation Length]

6.1. Power On

- Connect operation power (+ 24V, GND) to CN1 of Terminal PCB, connect 1-2 to J6 Jumper, 2-3 to J7 Jumper.
- When using PoE (Power over Ethernet), connect CN4 (Ethernet Port). At this time, connect 1-2 for J7 Jumper.
- Check the power input then turn ON the power S/W located on the front.
- Power LED (Green) lights on. "LOAD" displays that indicates loading of Version info. (Ux.xx) and sensor data. At the same time, it displays timer [Tx, Ex (0180~0001), O2 (1800~0001)] then "Warm" (warming up) followed by converting into measuring mode.
- It takes 30 min (O2) and approx. 3 min (180 sec, for toxic/flammable). Pressing RST (reset key) while 'WAlT' is flashing displays 'Warm' (warming up) and changes to measuring mode.

	- When the power switch turns ON, "UX.XX" Firmware Version information is displayed for 2 sec on LCD (concentration display part).
	- Initially, when sensor cartridge and main body exchanges information, "LOAD" is displayed. At the same time, 3 min (180 sec) or 30 min (for O2 setting) timer runs for sensor stabilization. At this time, pressing reset key changes to warming up mode.
	
	- When there is an error during self-test, "Fault" is displayed and trouble alarm runs. - When sensor cartridge is warming up, "Warm" message is displayed.
	- Upon completion of sensor cartridge warm-up, it counts from R5~R1 then enters measuring mode. - Count display is always displayed when it enters measuring mode from another mode.
	
	
	

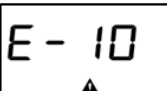
6.2. Measuring Mode

	- It displays gas concentration received from sensor cartridge on LCD digital display in numbers and the current flow rate in bar graph.
	- When there is an error in sensor cartridge, messages from "E-10" to "E-34", etc. flashes and trouble LED (Yellow) lights on. (Refer to Section 8. Error & Warning Message (Troubleshooting))
	- When input gas concentration from sensor cartridge is 10% higher than the set high scale value, "OUER" displays by flashing in 0.5 sec interval. - When gas concentration is detected to be above the alarm threshold and the alarm dwell time has passed, alarm function runs. - Alarm LED Lamp is turned on when alarm delay time is over. - Alarm relay turns on when it has passed the alarm dwell time. - When Alarm Latch Type is in "ON" mode and alarm function runs, the alarm status and gas concentration value stays (displayed) at the maximum value. When gas concentration decreases below the alarm value, alarm does not get released and "RESET" key must be ran to release it. - When Alarm Latch Type is in "OFF" mode, Alarm is released automatically in accordance to gas concentration.

6.3. Mode Configuration

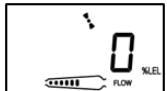
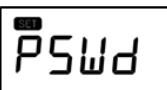
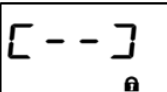
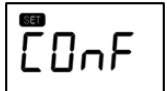
	- When "FUNC" key is pressed for 2 sec or longer in measuring mode, it enters password required step.
	- During password required step, ([ - - ]) is displayed for password input. - Initial factory setting is ([ - - ]) = [00] and the password can be changed from ([00]~[99]). Entering password followed by pressing FUNC (Function) key enters each mode. Using UP or DOWN key, each mode can be selected.
	
	- Using UP or DOWN key, it can enter internal mode. - Internal mode can be set for CONF, PRGM, CALB, ALARM, etc.

7.1. Mode Configuration

■ This device consists of the following menu configuration.

TYPE	Menu Display	Description	Notes
CONFIGURATION MODE	COnF	Internal Mode Configuration Setting	
PROGRAM MODE	Prgm	Gas Measurement Related Setting	
CALIBRATION MODE	CALb	Gas Calibration	
ALARM MODE	ALAm	Alarm Setting	
TIME MODE	tImE	Time Change	Factory Mode
SENSOR DATA MODE	S-dt	Sensor Data Output	Factory Mode
TEST	tEST	Test Mode	Factory Mode
FLOW MODE	FLOW	Flow Operation Setting Mode	Factory Mode
MAINTENANCE MODE	m-t	Internal Mode Configuration Setting	Factory Mode
NETWORK MODE	nEt	PoE related Ethernet Setting	Factory Mode
NETWORK SET	SEt	Forbidden Use (for Customizing)	Factory Mode

[Table 4. Mode Configuration]

7.2. Detailed Menu Configuration

Entire menu configuration for the device is as follows.

LEVEL1	LEVEL2	LEVEL3	DEFAULT
COnF	Add(Address)	OFF, 1~64 (Address for 485 Modbus Network)	1
	PSWd>Password)	0~99 (Password Setting)	00
	C-tm(Calibration Time)	OFF, 1~12 (Gas detector Calibration Frequency Setting)	OFF
	SUPr(Suppression)	OFF, 1~20 (Restriction ratio for measured gas value. Runs at 20% of full range)	07%
	PyrO(Pyrolyzer)	On, OFF (Pyrolyzer Consumption Current Use Setting)	OFF
	U3.04(Version)	Firmware Version Display	-
	End	-	-
Prgm	UnIT	PPM, PPB, %VOL, %LEL	%LEL
	dP-S(Decimal Point)	1000, 100.0, 10.00, 1.000 (Measurement Digit Setting)	100
	H-SL(High Scale)	1~9999 (Measurement Full Range(High Scale) Setting)	100
	End	-	-

LEVEL1	LEVEL2	LEVEL3	DEFAULT	
CALb	ZERO	no, YES	no	
	0	Current Zero Measurement	-	
	WAlt(Wait)	-	-	
	GOOd(Good)	For successful calibration, Good. For failed calibration, Fail.	-	
	0	Measurement after zero calibration	-	
	SPAN	no, YES	NO	
	45	Current Measurement		
	50	Standard gas value setting for span calibration	50%/F.R.	
	WAlt(Wait)			
	GOOd(Good)	For successful calibration, Good. For failed calibration, Fail.	-	
	50	Measurement after span calibration	-	
	End	-	-	
	ALAm	LACH(Latching)	On, OFF	OFF
		AL-t(Alarm relay type)	Energizer, De-Energizer	dE-E
FA-t(Fault relay type)		Energizer, De-Energizer	dE-E	
AL-1(Alarm 1)		Set to 90% of 1~ Full Range	20%/F.R.	
1H/1L (Alarm Operation Direction)		H: Rising Alarm / L: Lowering Alarm	1H	
1H00/1L00(Dead band)		0~99	1H00	
AL1t(Alarm1 time)		0~30sec(Alarm Dwell Time)	1sec	
A1rL(Alarm1 Relay)		On, OFF (Relay Use Setting)	On	
A1br(Alarm1 blinking)		On, OFF (Relay blinking Use Setting)	OFF	
AL-2(Alarm 2)		Set to 1~ Full Range	40%/F.S.	
2H/2L (Alarm Operation Direction)		H: Rising Alarm / L: Lowering Alarm	2H	
2H00/2L00(Dead band)		0~99	2H00	
AL2t(Alarm2 time)		0~30sec(Alarm Dwell Time)	1sec	
A2rL(Alarm2 Relay)		On, OFF (Relay Use Setting)	On	
A2br(Alarm2 blinking)		On, OFF (Relay blinking Use Setting)	OFF	
End				





[Table 5. Menu Table]

### 7.3. Configuration Mode



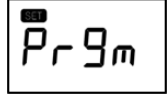
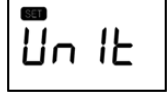

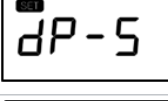
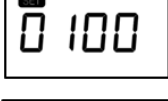
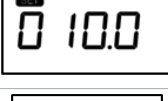
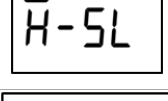

	- When "FUNC" key is pressed for 2 sec or longer in measuring mode at the same time, it enters password required step ([ - - ]).
	- (Lock) icon is displayed and it requires the password for gas detector. Initial factory setting is ([ - - ]) = [00] and the password can be changed from ([00]~[99]). Entering password followed by pressing FUNC (Function) key enters each mode. Using UP (▲) key or Down (▼) key, each mode can be selected.
	- Using ▲"key or "▼"key to select "COnf" (Configuration mode) then press "FUNC" key to enter configuration mode.
	- A designated address for gas detector is required for data network (RS-485, etc.) It is a mode that sets address. - Pressing "FUNC" KEY enters address setting function.
	- For address input, pressing ▲"key or "▼"key increases or decreases number, respectively. It can be set in a range between 01~64 and default is 1. - When a desired address (no.) is displayed, press "FUNC" key to set it and enter the next item.
	- It is PSWd (Password mode) Mode. - It is a password mode that gives authorization to change gas detector data. Pressing ▲"key or "▼"key increases or decreases password number, respectively. (Default: [00], [00]~[99])
	- Password can be set in a range between 00~99 and default is [00]. - When a desired password is displayed, press "FUNC" KEY to set it and enter the next item.
	- It is a mode that sets sensor calibration frequency in a unit of month. Pressing ▲"key or "▼"key increases or decrease number, respectively. (Default: OFF, [01]~[12])
	- Calibration frequency can be set in a range of 01~12 month and default setting is OFF (not used). - When a desired month is displayed, press "FUNC" KEY to set it and enter the next item.
	- It is a mode that sets suppression % that displays '0' for gas concentration when displaying SUPr (Suppression) Mode gas concentration. Pressing ▲"key or "▼"key increases or decreases % number, respectively. (Default: 07, [01]~[20])

	- It can be set in between 1%~20% of the full range and default is set at 07 (7%). - When a desired % is displayed, press "FUNC" KEY to set it and enter the next item.
	- It sets pyrolyzer usage and ▲"key or "▼"key is used to set whether to use it or not.
	- Set to ON when using pyrolyzer and to OFF when it is not used. Press "FUNC" key to set selected mode and enter the next item.
	- It is a mode that displays program version. - Pressing "FUNC" key displays "End", which is the next item for display.
	- It means that it has completed setting and changing of the configuration mode. Pressing "FUNC" key changes to menu mode.



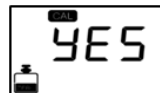



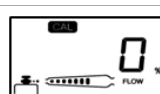



### 7.4. Program Setting

	<ul style="list-style-type: none"> <li>- When "FUNC" key is pressed for 2 sec or longer in gas concentration display mode at the same time, it enters menu selection mode.</li> <li>- Use "▲"key or "▼"key to select "Prgm" (Configuration mode) then press "FUNC" key to enter program setting mode.</li> </ul>
	<ul style="list-style-type: none"> <li>- It is a mode that sets gas concentration measurement unit. Pressing ▲"key or "▼"key changes unit icon on the right.</li> </ul>
	<ul style="list-style-type: none"> <li>- There are 4 types of measurement unit: PPM, PPB, %VOL, and %LEL. Default setting is %LEL.</li> <li>- When a desired unit icon is displayed, press "FUNC" KEY to set it and enter the next item.</li> </ul>
	
	<ul style="list-style-type: none"> <li>- "dP-5" (decimal point) message is displayed for setting decimal place for gas concentration number.</li> <li>- When "FUNC" KEY is pressed, it enters decimal setting mode.</li> </ul>
	<ul style="list-style-type: none"> <li>- Decimal point is used when it is necessary to change decimal point for measured range. Decimal point position is set by pressing "▲" KEY or "▼" KEY to change in 4 different options. (0.000, 00.00, 000.0, 0000)</li> <li>- When a desired decimal place is displayed, press "FUNC" KEY to set the decimal place and enter the next item.</li> </ul>
	
	<ul style="list-style-type: none"> <li>- "H-SL" (High scale) message is displayed for high scale setting function that sets the max. value of measuring range.</li> <li>- When "FUNC" KEY is pressed, it enters high scale setting mode.</li> <li>- High scale value is set to a range defined by domestic regulations as default.</li> </ul>
	<ul style="list-style-type: none"> <li>- High scale changes a set value according to measuring range. Scale value increases or decreases upon pressing "▲" KEY or "▼" KEY, respectively.</li> <li>- When a desired high scale is displayed, press "FUNC" KEY to set it and enter the next item.</li> </ul>
	<ul style="list-style-type: none"> <li>- It means that it has completed setting and changing of the program mode. Pressing "FUNC" key changes to menu mode.</li> </ul>





### 7.5. Zero Calibration

	<ul style="list-style-type: none"> <li>- When "FUNC" key is pressed for 2 sec or longer in gas concentration display mode at the same time, it enters menu selection mode.</li> <li>- Use "▲"key or "▼"key to select "CALb" (Calibration mode) then press "FUNC" key to enter calibration mode.</li> </ul>
	<ul style="list-style-type: none"> <li>- Pressing "FUNC" key when "ZERO" icon on bottom left side flashes enters Zero Calibration Mode.</li> </ul>
	<ul style="list-style-type: none"> <li>- It displays selection for Zero Calibration.</li> <li>- Using "▲"key or "▼"key, select "YES" then press "FUNC" key to display gas concentration that is being measured currently.</li> </ul>
	
	<ul style="list-style-type: none"> <li>- Use a calibration tool to inject clean air or 100% nitrogen gas at a flow rate of 500 mL/min (300 mL/min for pyrolyzer connection) to the sensor for ~1 min.</li> <li>- When the measurement is stable after gas injection, press "FUNC" key to automatically run Zero calibration and display "WAIT" message.</li> </ul>
	
	<ul style="list-style-type: none"> <li>- When the calibration is successful, "GOOd" is displayed for 2 sec then it changes to calibration concentration display mode.</li> <li>- When the calibration is unsuccessful "FAIL" is displayed for 2 sec then it changes to calibration concentration display mode.</li> </ul>
	
	<ul style="list-style-type: none"> <li>- Pressing "FUNC" key in calibration concentration display mode immediately enters Span Calibration Mode. Pressing "RST" key returns to "CALb" (Calibration mode).</li> </ul>

### 7.6. Span Calibration

	<ul style="list-style-type: none"> <li>- When "FUNC" key is pressed for 2 sec or longer in gas concentration display mode at the same time, it enters menu selection mode.</li> <li>- Use "▲"key or "▼"key to select "CALb" (Calibration mode) then press "FUNC" key to enter calibration mode.</li> </ul>
	<ul style="list-style-type: none"> <li>- Using "▲"key or "▼"key, select "SPAN" Icon on the bottom left then press "FUNC" key to enter span calibration mode.</li> </ul>
	<ul style="list-style-type: none"> <li>- Select whether to proceed to Span Calibration of not. Using "▲"key or "▼"key, select "YES" then press "FUNC" key.</li> </ul>
	
	<ul style="list-style-type: none"> <li>- Using a calibration tool, inject the standard gas into the sensor at a flow rate of 500 mL/min (300 mL/min for pyrolyzer connection) for 90 sec. After injecting gas, press "FUNC" key when the measurement has been stabilized,</li> </ul>
	<ul style="list-style-type: none"> <li>- It is a mode that sets standard gas value when concentration number is flashing. Use "▲"key or "▼"key to set a value then press "FUNC" key to automatically run Span calibration. "WAIt" message will display.</li> </ul>
	
	<ul style="list-style-type: none"> <li>- When the calibration is successful "GOOd" is displayed for 2 sec then it changes to calibration concentration display mode.</li> <li>- When the calibration is unsuccessful "FAIL" is displayed for 2 sec then it changes to calibration concentration display mode.</li> </ul>
	
	<ul style="list-style-type: none"> <li>- Pressing "FUNC" key in calibration concentration display mode displays "End". Pressing "FUNC" key again returns to "CALb" mode.</li> </ul>
	<ul style="list-style-type: none"> <li>- It means that it has completed setting and changing of the program mode. Pressing "FUNC" key changes to menu mode.</li> </ul>



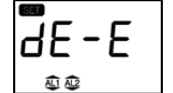
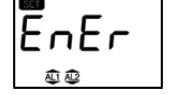
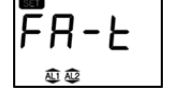
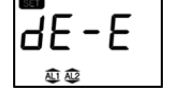
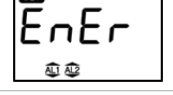
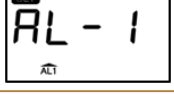

### 7.7. Alarm Data Setting (Alarm Mode)

	<ul style="list-style-type: none"> <li>- When "FUNC" key is pressed for 2 sec or longer in gas concentration display mode at the same time, it enters menu selection mode.</li> <li>- Use "▲"key or "▼"key to select "ALAm" (Calibration mode) then press "FUNC" key to enter alarm setting mode.</li> </ul>
	<ul style="list-style-type: none"> <li>- It is a mode that sets alarm latch type. Pressing "▲"key or "▼"key changes "ON" and "OFF" mode.</li> </ul>
	<ul style="list-style-type: none"> <li>- When a desired alarm latch type is displayed, press "FUNC" key to set it and enter the next item.</li> <li>- Alarm Latch Type has two modes; "ON" and "OFF". "OFF" mode automatically resets alarm. When "ON", the user must press "RESET" key to release and reset the alarm.</li> </ul>
	<ul style="list-style-type: none"> <li>- It is a mode that sets energizer function of the alarm relay. Pressing "FUNC" key enters alarm relay energizer setting mode.</li> </ul>
	<ul style="list-style-type: none"> <li>- Pressing "▲"key or "▼"key changes "dE-E" and "EnEr" modes.</li> <li>- When a desired energizer mode is displayed, press "FUNC" KEY to set it and enter the next item.</li> <li>- Energizer mode has two modes; "dE-E" and "EnEr". When it is in "dE-E" mode, alarm contact is automatically connected upon an event of alarm with relay contact connection turned off. In "EnEr" mode, the contact connection turns off upon an event of alarm with the relay contact connection on.</li> </ul>
	
	<ul style="list-style-type: none"> <li>- It is a mode that sets energizer function of the Fault relay. Pressing "FUNC" key Fault relay energizer setting mode.</li> </ul>
	<ul style="list-style-type: none"> <li>- Pressing "▲"key or "▼"key changes "dE-E" and "EnEr" modes.</li> <li>- When a desired energizer mode is displayed, press "FUNC" KEY to set it and enter the next item.</li> <li>- Energizer mode has two modes; "dE-E" and "EnEr". When it is in "dE-E" mode, alarm contact is automatically connected upon an event of fault with relay contact connection turned off. In "EnEr" mode, the contact connection turns off upon an event of fault with the relay contact connection on.</li> </ul>
	
	<ul style="list-style-type: none"> <li>- Alarm1 setting mode message displays "AL-1".</li> </ul>

	<ul style="list-style-type: none"> <li>- It is a mode that sets Alarm1 Level threshold. It can be set in a range of 1~90% of set high scale value.</li> <li>- Pressing "▲"key or "▼"key increases or decreases Alarm1 threshold, respectively.</li> <li>- When a desired alarm1 threshold is displayed, press "FUNC" KEY to set it and enter the next item.</li> <li>- Alarm level is set to the concentration outlined in domestic regulations as factory setting</li> </ul>
	<ul style="list-style-type: none"> <li>- It is a mode to set a direction of Alarm 1 operation. Pressing "▲"key or "▼"key displays "1H" or "1L", respectively.</li> <li>- "1H" sets the alarm to run at Alarm1 threshold or higher. "1L" mode runs at Alarm 1 threshold or lower.</li> <li>- When a desired mode is displayed, press "FUNC" KEY to set and enter the next item.</li> <li>- Factory default for alarm type is set at flammable: 1H, 2H/ Oxygen: 2H, 1L/ Toxic: 1H&amp;2H Type.</li> </ul>
	<ul style="list-style-type: none"> <li>- It is a mode that sets Dead band value for Alarm1 operation. Use "▲"key or "▼"key to set a value.</li> <li>- When Alarm 1 is in "1H" mode, Alarm 1 operates at values above the sum of Alarm threshold and dead band values and releases below dead band value subtracted from Alarm threshold.</li> <li>- When Alarm 1 is in "1L" mode, Alarm 1 operation below dead band value subtracted from Alarm threshold and releases above the sum of Alarm1 threshold and dead band value.</li> <li>- When a desired Alarm1 dead band value is displayed, press "FUNC" KEY to set and enter the next item.</li> <li>- This mode is to set a hysteresis value to remove a phenomenon where alarm1 warning runs on/off repeatedly when the gas concentration reaches close to the set alarm1 threshold. Factory default is set to 0.</li> <li>- Ex.) When threshold is 20% LEL/Dead band: 2% LEL, the alarm runs at 22% LEL and is released at 18% LEL with 20% LEL as the reference.</li> </ul>
	<ul style="list-style-type: none"> <li>- Alarm1 setting mode message displays "AL1t".</li> </ul>
	<ul style="list-style-type: none"> <li>- It is a function to prevent instantaneous malfunction of gas detector due to external shock and noise other than from normal operation and time can be set in a range between 0~30 sec.</li> <li>- For Alarm1 dwell time setting, press "▲"key or "▼"key to increase or decrease in unit of 1 sec, respectively.</li> <li>- When a desired Alarm 1 dwell time is displayed, press "FUNC" KEY to set it and enter the next item.</li> <li>- Ex.) Alarm threshold value: 20% LEL / Delay time: When it is at 5 sec, Alarm triggers when the measured value is above the set value based on 20%LEL for 5 sec or longer. When it goes down below the set value within 5 sec, alarm is not triggered.</li> </ul>
	<ul style="list-style-type: none"> <li>- Alarm1 (Relay) contact output setting mode message displays "A1rL".</li> </ul>
	<ul style="list-style-type: none"> <li>- It is a mode that sets alarm1 contact output. Pressing "▲"key or "▼"key changes "ON" and "OFF" mode.</li> <li>- When a desired Alarm 1 contact output mode is displayed, press "FUNC" KEY to set it and enter the next item.</li> <li>- Alarm1 contact output mode has two modes; "On" and "Off". In "Off" mode alarm1 contact is not outputted and in "On" mode, it is outputted.</li> </ul>

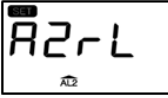
	<ul style="list-style-type: none"> <li>- Alarm1 blink relay mode sets alarm relay output to turn On/Off repeatedly in 1 sec interval.</li> </ul>
	<ul style="list-style-type: none"> <li>- Default is OFF, and when ON, contact output runs On/Off repeatedly in 1 sec interval while Alarm1 is running.</li> </ul>
	<ul style="list-style-type: none"> <li>- Alarm2 setting mode message displays "AL-2".</li> </ul>
	<ul style="list-style-type: none"> <li>- It is a mode that sets Alarm2 Level threshold. It can be set in a range of 1~set high scale value.</li> <li>- Pressing "▲"key or "▼"key increases or decreases Alarm2 threshold, respectively.</li> <li>- When a desired alarm 2 threshold is displayed, press "FUNC" KEY to set it and enter the next item.</li> <li>- Alarm level is set to the concentration outlined in domestic regulations as factory setting.</li> </ul>
	<ul style="list-style-type: none"> <li>- It is a mode to set a direction of Alarm 2 operation. Pressing "▲"key or "▼"key displays "2H" or "2L", respectively.</li> <li>- "2H" sets the alarm to run at Alarm1 threshold or higher. "2L" mode runs at Alarm 2 threshold or lower.</li> <li>- When a desired mode is displayed, press "FUNC" KEY to set and enter the next item.</li> <li>- Factory default for alarm type is set at flammable: 1H&amp;2H/ Oxygen: 2H&amp;1L/ Toxic: 1H&amp;2H Type.</li> </ul>
	<ul style="list-style-type: none"> <li>- It is a mode that sets Dead band value for Alarm2 operation. Use "▲"key or "▼"key to set a value.</li> <li>- When Alarm 2 is in "2H" mode, Alarm 2 operates at values above the sum of Alarm and dead band values and releases below the sum.</li> <li>- When Alarm 2 is in "2L" mode, Alarm 2 operation below dead band value subtracted from Alarm threshold and releases above the sum of Alarm threshold and dead band value.</li> <li>- When a desired Alarm2 dead band value is displayed, press "FUNC" KEY to set and enter the next item.</li> <li>- This mode is to set a hysteresis value to remove a phenomenon where alarm2 warning runs on/off repeatedly when the gas concentration reaches close to the set alarm1 threshold. Factory default is set to 0.</li> <li>- Ex.) When threshold is 20% LEL/Dead band: 2% LEL, the alarm runs at 22% LEL and is released at 18% LEL with 20% LEL as the reference.</li> </ul>
	<ul style="list-style-type: none"> <li>- Alarm2 setting mode message displays "AL2t".</li> </ul>
	<ul style="list-style-type: none"> <li>- It is a function to prevent instantaneous malfunction of gas detector due to external shock and noise other than from normal operation and time can be set in a range between 0~60 sec.</li> <li>- For Alarm2 dwell time setting, press "▲"key or "▼"key to increase or decrease in unit of 1 sec, respectively.</li> <li>- When a desired Alarm2 dwell time is displayed, press "FUNC" KEY to set it and enter the next item.</li> <li>- Ex.) Alarm threshold value: 20% LEL / Delay time: When it is at 5 sec, Alarm triggers when the measured value is above the set value based on 20%LEL for 5 sec or longer. When it goes down below the set value within 5 sec, alarm is not triggered.</li> </ul>

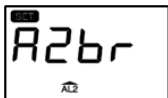

	- Alarm2 (Relay) contact output setting mode message displays "A2rL".
	- It is a mode that sets alarm2 contact output. Pressing "▲"key or "▼"key changes "ON" and "OFF" mode. - When a desired Alarm2 contact output mode is displayed, press "FUNC" KEY to set it and enter the next item. - Alarm2 contact output mode has two modes; "On" and "Off". In "Off" mode alarm1 contact is not outputted and in "On" mode, it is outputted.
	- Alarm2 blink relay mode sets alarm relay output to turn On/Off repeatedly in 1 sec interval.
	- Default is OFF, and when ON, contact output runs On/Off repeatedly in 1 sec interval while Alarm2 is running.
	- It means that it has completed setting and changing of the program mode. Pressing "FUNC" key changes to menu mode.

### 8.1. Fault List

FAULT	DESCRIPTION & CONDITION	CAUSE
E-10	When a sensor cartridge is not equipped in the main body or it is defective.	1) Sensor cartridge connection fault 2) Sensor cartridge unit fault
E-11	When there is no communication between the main body and sensor cartridge.	1) Sensor Cartridge Unit Fault 2) Main Body Fault
E-12	When there is no gas sensor in Sensor Cartridge.	Sensor cartridge unit fault
E-13	When EEPROM of Sensor PCB is defective.	Sensor Cartridge EEPROM Fault
E-14	When sensor status is defective during self-test.	Fault in gas sensor function built in the sensor cartridge.
E-20	When flow sensor does not run.	Flow sensor fault in Main Unit.
E-21	When flow rate of flow sensor is low.	When flow rate is measured to be below 0%.
E-22	When flow rate of flow sensor is high.	When flow rate is measured to be above 120%.
E-23	When flow rate at flow rate sensor is below the low level (250 ml)	When flow rate is measured to be below the low level (during L-FL on).
E-30	When pyrolyzer current is measured to be below 100 mA.	1) Pyrolyzer connection fault 2) Pyrolyzer internal hot-wire fault
E-31	When EEPROM in the main unit is not detected.	EEPROM fault in Main Board.
E-32	When pyrolyzer current is measured to be above 900mA.	Pyrolyzer fault
E-34	When gas measurement is hunting continuously.	1) Check gas sensor measurement status. 2) Check noise input from input power. 3) Sensor cartridge unit fault 4) Main Body Fault

[Table 6. Fault List]

### 8.2. Warning List

WARNING	DESCRIPTION & CONDITION	CAUSE
W-00	In case of time setting error	Main unit time setting error
W-01	When calibration validation has passed.	Exceeded calibration validation period.
W-02	When manufacture data of sensor is not entered.	Sensor Manufacturing Date Error

[Table 7. Fault List]

### 8.3. Recovery List

NO	CAUSE	SOLUTION
1	Sensor cartridge connection fault	1) Check status of sensor cartridge connector 2) Change sensor cartridge
2	Sensor cartridge unit fault	Change sensor cartridge
3	Gas sensor function failure	Change gas sensor
4	Sensor Cartridge EEPROM Fault	1) Perform Factory Initialization then correct parameter and re-calibrate 2) Change sensor cartridge when the same problem occurs again
5	Flow rate sensor fault	Change main unit
6	When flow rate is measured to be below 0%.	1) Check flow rate at inlet and outlet. 2) Change the main unit if it is not from internal clogging.
7	When flow rate is measured to be above 120%.	Change main unit
8	Pyrolyzer connection fault	1) Check status of pyrolyzer connector 2) Change pyrolyzer if the connector is normal.
9	Pyrolyzer internal hot-wire fault	Change Pyrolyzer
10	EEPROM fault in Main Board.	1) Perform Factory Initialization then correct parameter and re-calibrate 2) Change the main body when the same problem occurs again
11	Pyrolyzer fault	Change Pyrolyzer
12	Main Body Fault	Change main unit
13	Main unit time setting error	1) Reset time 2) Change Backup Battery 3) Change main unit
14	Exceeded calibration validation period.	Re-calibrate sensor or change sensor.
15	Sensor Manufacturing Date Error	Re-calibrate sensor

[Table 8. Recovery List]

### 9.1. MODBUS RS485

#### 9.1.1. Interface setting

- Data Format: RTU
- Baud rate: 9600 bps
- Data bits: 8bits
- Stop bit: 1bits
- Parity: Even
- For details, please go to [www.modbus.org](http://www.modbus.org)

#### 9.1.2. MODBUS RS485 Address Map

TYPE	ADDRESS	BITS	DESCRIPTION
Integer Gas Measured Value	30001	BIT15~0	Gas measurement value (integer type / decimal point not considered)
Integer High Scale	30002	BIT15~0	High Scale setting value (integer type / decimal point is not considered)
Integer Primary Alarm Setting Value	30003	BIT15~0	Primary alarm setting value (integer type / decimal point is not considered)
Integer Secondary Alarm Setting Value	30004	BIT15~0	Secondary alarm set value (integer type / decimal point is not considered)
Gas detector status value 2	10001	BIT0	Alarm 1
	10002	BIT1	Alarm 2
	10003	BIT2	Fault Bit
	10004	BIT3	MENU Mode (enter Menu)
	10005	BIT4	Test
	10006	BIT5	CAL
	10007	BIT6	Reserved
	10008	BIT7	Toggle Bit (Invert bits in 2 sec intervals)
Test Pattern On	3	BIT0~7	Gas Detector Test Pattern On (GAS Highscale value), Write 0xFF
Normal Restart	2	BIT0~7	Gas Detector Normal Operation restart, Write 0x00

[Table 9. RS485 MODBUS Address Configuration]

9.2. MODBUS/TCP Interface

9.2.1. Interface setting

- MMODBUS Port Number 502
- For details, please go to [www.modbus.org](http://www.modbus.org)

9.2.2. MODBUS TCP/IP Address Map

TYPE	ADDRESS	BITS	DESCRIPTION
Gas detector State value1	40001	BIT0~3	Monitoring state
			0: Warm up
			1: Measure Mode
			2: Measurement mode where alarm output is prohibited (check mode)
			3: Reserved
			4: Reserved
			5: Reserved
			6: Reserved
			7: 4 ~ 20mA Calibration Mode
			8: Flow Calibration Mode
		9~15: Reserved	
		BIT4	Fault Active State
		BIT5	Reserved
		BIT6	Alarm 1 Active State
		BIT7	Alarm 2 Active State
BIT8	Alarm1 Relay Active State		
BIT9	Alarm2 Relay Active State		
BIT10	Fault Relay Active State		
BIT11	Toggle Bit (Invert bits in 2 sec intervals)		
BIT12	GAS Over State		
BIT13~15	Reserved		
Heart Bit	40002	BIT0~15	1 increments from 0 to 65535 in 1 second increments
Real type gas measurement	40003	BIT0~15	Gas Concentration in floating point format word 1 of 2
	40004	BIT0~15	Gas Concentration in floating point format word 2 of 2
Integer type gas measurement	40005	BIT0~15	Gas Concentration in integer Format (Integer / Decimal Point not considered)
Error Code	40006	BIT0~15	Error Code

TYPE	ADDRESS	BITS	DESCRIPTION
Decimal point and units	40007	BIT0~2	Decimal point indicator
			0: 0 Point
			1: 1 Point
			2: 2 Point
			3: 3 Point
		4~7: Reserved	
		BIT3~7	Reserved
		BIT8~11	Concentration units
			0: Reserved
			1: PPM
			2: PPB
			3: Reserved
4: % Volume			
5~7: Reserved			
8: % LEL			
BIT12~15	Reserved		
Gas detector Temperature measurement	40008	BIT0~15	Temp(Signed 16bit Integer) O2 detector
Reserved	40009	BIT0~15	Reserved
Reserved	40010	BIT0~15	Reserved
Flow Measures	40011	BIT0~15	Flow Measures
Reserved	40012	BIT0~15	Reserved
Real type primary alarm setting value	40013	BIT0~15	Alarm1 Value in floating point format word 1 of 2
	40014	BIT0~15	Alarm1 Value in floating point format word 2 of 2
Real type 2nd alarm set value	40015	BIT0~15	Alarm2 Value in floating point format word 1 of 2
	40016	BIT0~15	Alarm2 Value in floating point format word 2 of 2
Reserved	40017	BIT0~15	Reserved
Reserved	40018	BIT0~15	Reserved
Gas detector State value 2	40019	BIT0	Alarm1
		BIT1	Alarm2
		BIT2	Fault Bit
		BIT3	MAINTENANCE (Inspection mode)
		BIT4	TEST
		BIT5	CAL
		BIT6	Reserved
		BIT7	Sensor Cartridge Error Bit

구분	ADDRESS	BITS	DESCRIPTION
Gas detector State value 2	40019	BIT8	Flow Error Bit
		BIT9	Internal Communication Error
		BIT10	Pyrolyzer Error Bit
		BIT11~15	Reserved
Real High Scale Setting	40020	BIT0~15	High Scale Value in floating point format word 1 of 2
	40021	BIT0~15	High Scale Value in floating point format word 2 of 2
Gas detector status value 2	10001	BIT0	Alarm1
	10002	BIT1	Alarm2
	10003	BIT2	Fault Bit
	10004	BIT3	MENU Mode (Enter Menu)
	10005	BIT4	TEST
	10006	BIT5	CAL
	10007	BIT6	Reserved
	10008	BIT7	Toggle Bit (Invert bits in 2 sec intervals)

[Table 10. MODBUS/ TCP Address Configuration]

10.1. GTD-5000 Standard Type

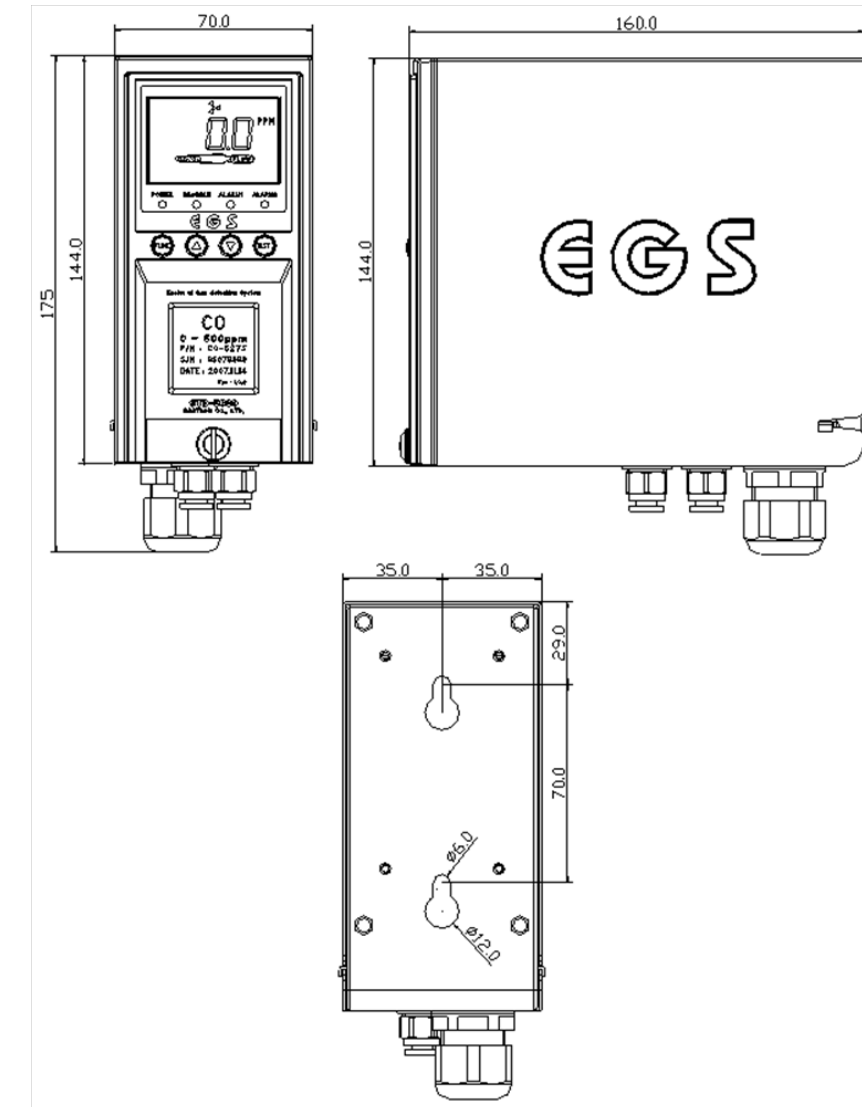

[Figure 14. GTD-5000 Dimension]

## 10.2. GTD-5000 & PY-1000

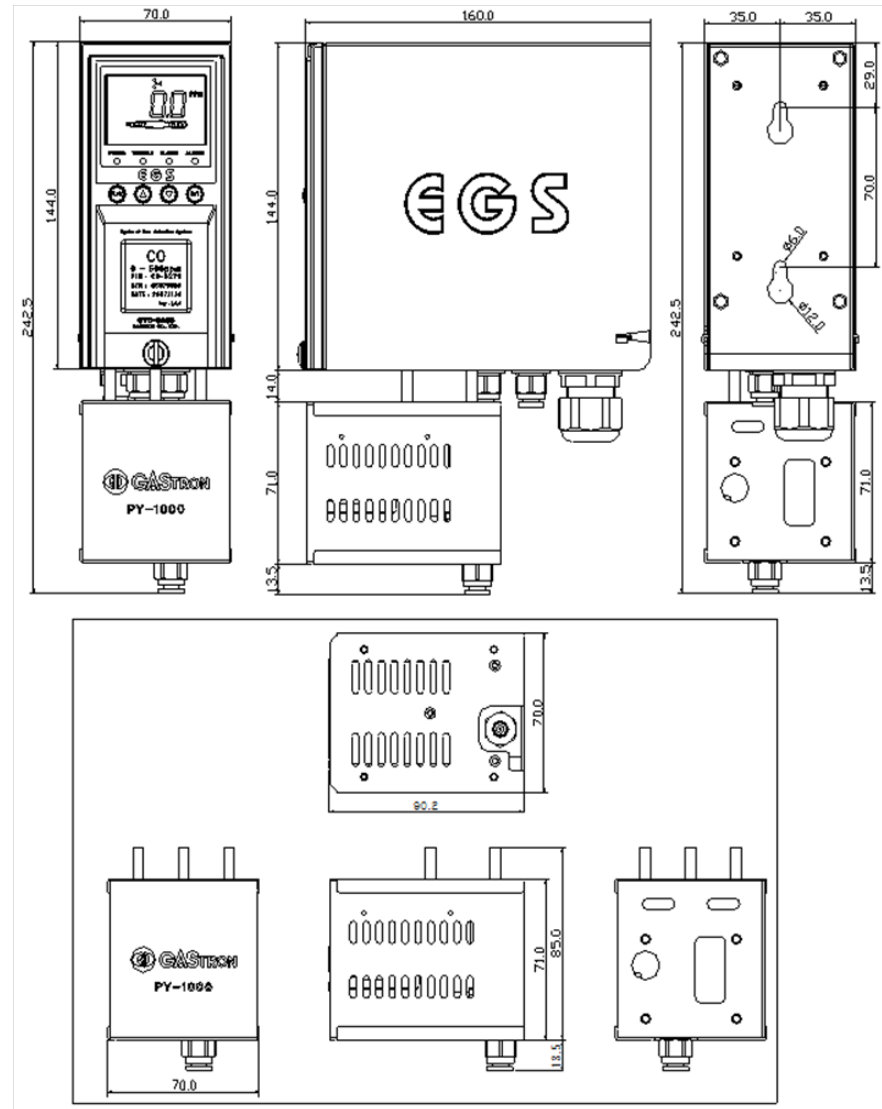

[Figure 15. GTD-5000 and PY-1000]

## 10.3. GTD-5000 & PY-2000

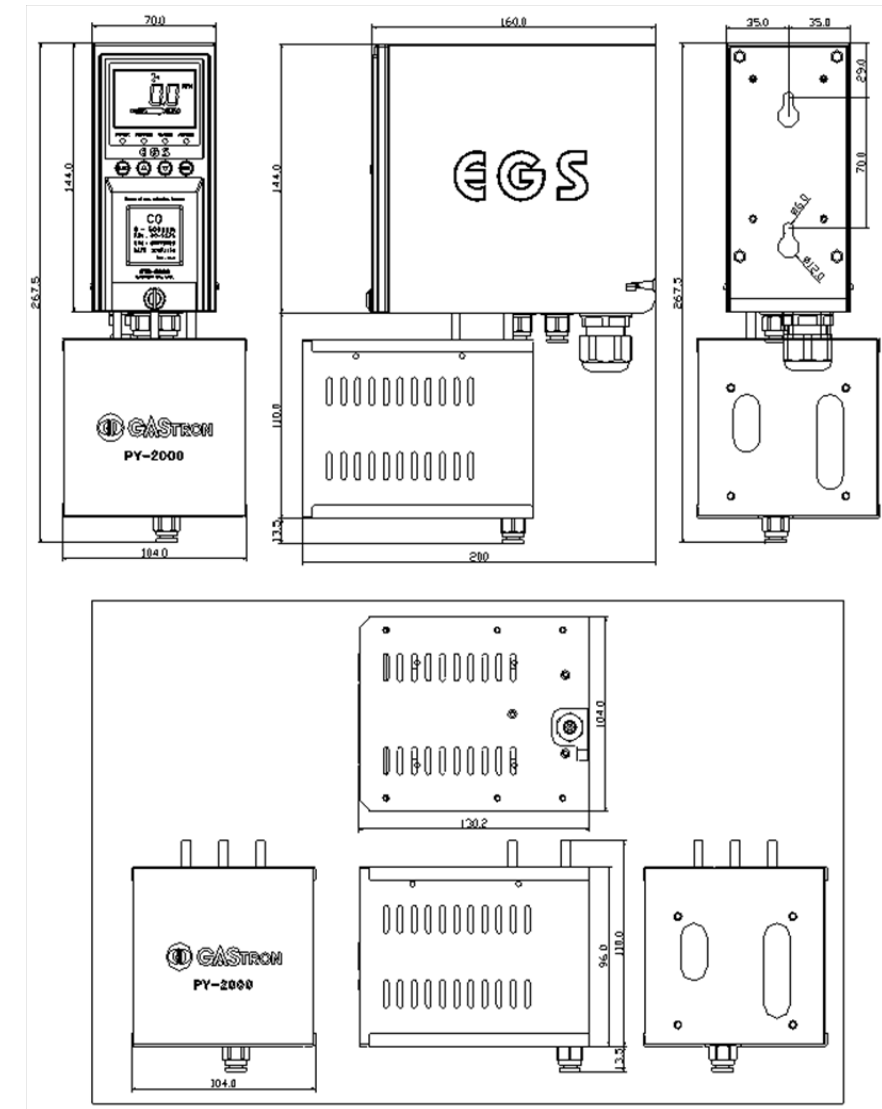

[Figure 16. GTD-5000 and PY-2000]

### 11.1. Selecting a Place for Installation (Occupational Health & Safety Act Data)

A gas leak detector alarm shall be installed in the following places.

- Around chemical equipment and accessories that have concerns of gas leak. This includes compressors, valves, reactors, pipe joints, etc. installed inside and outside of a building that handle combustible and toxic materials.
- Places that are easier for gases to stay such as areas around manufacturing facilities with ignition sources like heating furnace, etc,
- Areas around equipment for filling combustible and toxic materials.
- Substations, panel rooms, control rooms, and etc. located within explosive area.
- Other areas that are easier for gases to stay.

### 11.2. Selecting a Site for Installation (High-Pressure Gas Safety Control Act Data)

Gas detector of gas leak detector alarm must be installed as close to the areas with concerns of gas leakage as possible. However, for areas where direct gas leakage is not expected but are easier for leaked gas to stay, the detector must be installed at the point 1 of the following.

- Gas leak detector alarm installed outside a building shall be installed at points where gas is likely to stay in consideration to wind direction, wind speed, specific gravity of gas, etc.
- Gas leak detector alarm installed inside a building shall be installed near the floor when the specific gravity of gas is heavier than air and near ventilation of ceiling when it is lighter than air.
- Alarm for gas leak detector alarm must be installed at sites where the gas detector is installed and workers are present.

### 11.3. Precautions during Installation

Sensor element of gas detector is not constructed with tight seal, thus, it must be installed in areas with electrical impedance such as rainwater, etc. Penetration of rainwater, etc. in sensor part can cause loss of device function.

- Avoid areas with vibration or shock.
- Areas with vibration or shock can affect the output value.
- Avoid areas with high temperature and humidity for installation.
- High temperature and humidity can cause malfunction.
- Avoid electronic noise for installation. Avoid areas with high frequency or high voltage as much as possible for installation. (Ex.: Areas close to motor, pump, high voltage cables, etc.)

- Install in areas where maintenance is convenient. Regular maintenance and correction is required for gas detector. Avoid areas where it is inconvenient for maintenance work.

### 11.4. Cable Wiring Work

Shield-type cable must be used to prevent the effects from external noise. To protect from external damage, cable duct, conduct pipe. Flexible, etc. must be used.

Interface between two cables must be avoided, however, in an unavoidable cases, use a junction box for connection.

For high-pressure packing type cable inlet, cables with an appropriate external diameter for the internal size of the packing must be used. Cable gland shall be tightened sufficiently to prevent inflow of gas and flame.

During high-pressure explosion proof metal pipe construction, a sealing fitting must be installed inside the metal pipe and compound must be filled after completion of the work to prevent movement of flame from explosion. Other joints and connections must be waterproofed.

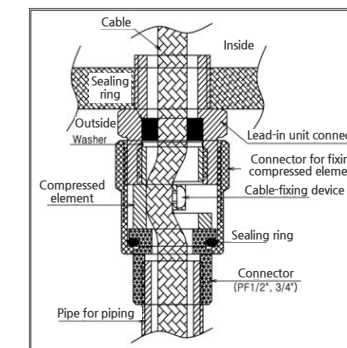

[Figure 17. High-Pressure Packing Type]

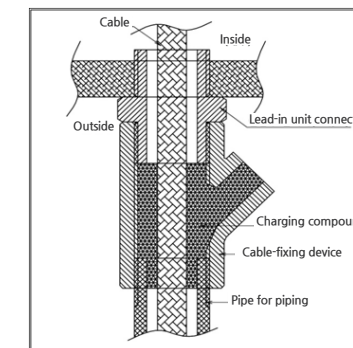

[Figure 18. Y Sealing Compound]

Version	Contents	Date
Rev0.0	Initial Revision of Manual	2012.05.31
Rev1.0	* Added alarm write address among MODBUS TCP Address (40001, 40002)	2013.05.02
Rev2.0	1. United relay contact method to SPDT (7 Page, 44 Page) 2. Corrected Typo 3. Applied new address	2014.07.08
Rev3.0	1. Added Color LCD Menu 2. Added Base Zero/Base Span Function 3. Added Self-test Error Code 4. Added Self-test ON/OFF function	2015.01.19
Rev3.10	1. Added Menu (AL-t, FA-t, AOO) 2. Changed Version Display Method	2015.03.20
Rev3.11	Added Items related to forbidden use in SET Menu.	2015.04.25
Rev3.12	Changed to Naver Font	2016.05.13
Rev3.13	1. Categorized Temperature/Humidity for Product and Sensor Use 2. Changed Display for change in the initial stabilization time from 1 min → 2 min. 3. Changed Maintenance Mode (Deleted Auto Zero Function, Added O2_En Function) 4. Changed RS485 Address (10000 number) 5. Added Serial Address to MODBUS TOP Address 6. Added E-34 7. Changed relay contact method to SPST (7 Page, 44 Page) 8. Corrected Typo 9. Applied Shape with Terminal Block change	2016.05.26
Rev4.0	Separated Factory Mode Manual	2016.09.29
Rev4.1	1. Corrected Typo 2. Added Menu (SEt) 3. Corrected Pyrolyzer Fault Current Value (34 Page)	2017.03.06
Rev4.2	1. Changed 4~20 mA output in maintenance mode 2. Added Address for RS-485	2017.05.04
Rev4.3	1. Changed Warming-up time 2. Corrected part of detailed operation	2017.06.26
Rev4.4	1. Added Warning Message 2. Added 3-Wire Sink Operation Method 3. Corrected Typo	2017.11.29
Rev4.5	1. Correct typos and mistyped content 2. Modify Modbus Address Map 3. Modify Terminal Picture	