



Headquarters / Engineering research laboratory :
23 Gunpo Advanced Industry 1-ro(Bugok-dong), Gunpo-si, Gyeonggi-do
Tel +82-31-490-0800 Fax +82-31-490-0801

Yeongnam business office / Plant :
55 Gonghangap-gil 85beon-gil, Gangseogu, Busan Metropolitan City
Tel +51-973-8518 Fax +51-973-8519

E-mail : info@gastron.com

www.gastron.com

GTC-200A

Instruction Manual

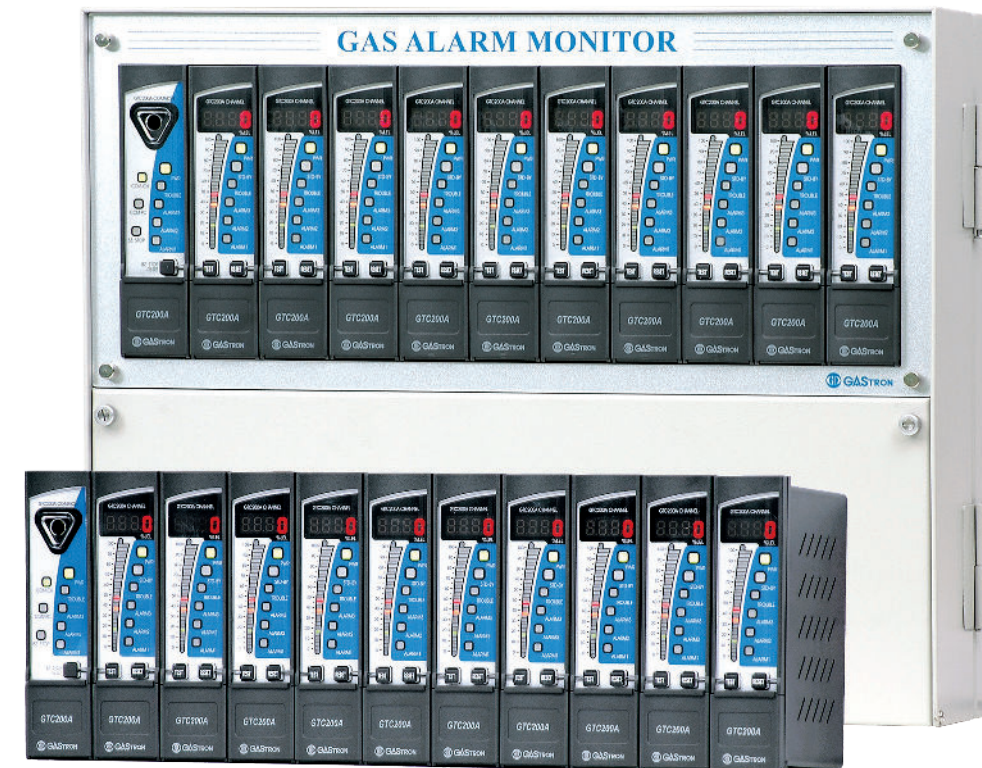

Read in detail for correct use.

Gas & Flame Detection System

GASTRON

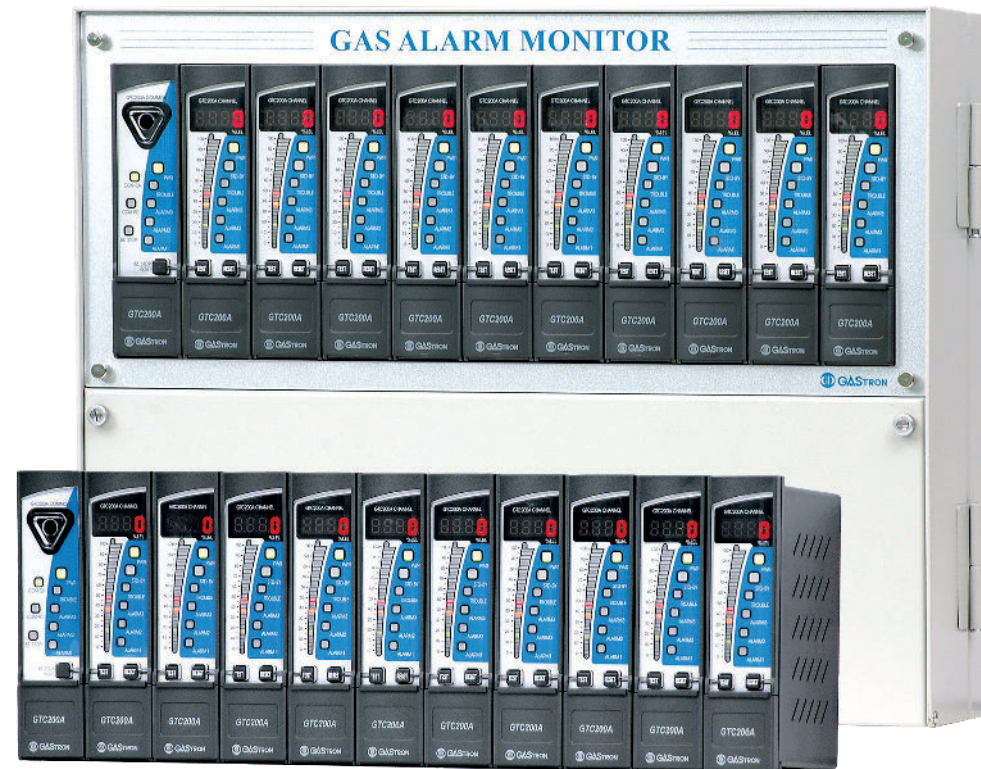

When abnormalities occur after purchasing the product,
please contact the following address.

- Address : 23 Gunpo Advanced Industry 1-ro,
Gunpo-si, Gyeonggi-do
- Tel : 031-490-0800
- Fax : 031-490-0801
- URL : www.gastron.com
- e-mail : info@gastron.com

We sincerely thank you for purchasing the product of Gastron Co. Ltd.

Our Gastron Co.Ltd. is a company specialized in Gas detector and Gas Monitoring System, being recognized by many consumers due to the best quality and use convenience. We always enable you consumers to find desired products nearby and are ceaselessly studying and striving for development of Gas detectors satisfying customers. From now on, solve all anguishes concerning Gas detector with the products of Gastron Co. Ltd, We Gastron Co. will take a responsibility and give you satisfaction.

In the present instruction manual, operation method for Gas detector as well as simple methods for maintenance and repair, etc. are recorded. If you read it in detail and keep it well, for reference when you have questions, then it will give you much help.

- For accurate operation of Gas detector, check up and calibrate for more than once in every 6 months.
(* See No. 13 of KOSHA GUIDE : P-135-2013 / 8.3 paragraph on qualification and calibration)
- For accurate operation of Gas detector, checkup and calibration with calibration gas before measurement is recommended.
- When not calibrated, it may cause malfunction of the equipment due to problems resulting from Sensor aging.
- When the present instrument should be dismantled, those with professional skills for Gas detector should conduct the operation.
- For power supply cable, wire specifications should be determined by referring to the item of "Length of installed cable".
- For the contents on checkup and calibration of Gas detector, please use our company's engineering department , e-mail, or web site.

The present product and the product manual can be changed without advance notice for performance improvement and use convenience of the product.

* KOSHA GUIDE : P-135-2013

Calibration should be executed at periods required by the manufacturer, and should be executed in every quarter unless there are separate calibration periods.

1. Overview	6	9. How to operate Channel Unit	23
2. Features	6	9.1. Power ON	23
3. Specifications for channel card	6	9.2. Gas Measuring Mode	23
3.1. Common Alarm Unit	6	9.3. Test Mode	24
3.2. Channel Control Unit	7	9.4. Checkup mode (Stand-by Mode)	24
3.3. Power Unit (Option)	7	9.5. Operation setting	25
3.4. Environmental Specifications	8	9.5.1. PROGRAM MODE	25
4. Specifications for Wall Mount product	8	9.6. ALARM Mode	27
5. Name and description of each part	9	9.7. Maintenance Mode	29
5.1. Configuration and description of Power unit	9	10. Outline drawing and Dimensions	31
5.2. Configuration and description of warning unit (Common unit)	10	10.1. Power unit	31
5.3. Configuration and description of channel unit (Channel unit)	12	10.2. Common Unit	31
5.4. Configuration and description of Wall mount type	14	10.3. Channel Unit	32
6. Installation	16	10.4. Panel mount type	33
6.1. Power supply and signal configuration for Channel Unit	16	10.5. Wall mount type(Power Unit applied)	34
6.2. Power supply configuration for Wall Mount Type	17	10.6. Wall mount type(Power Unit not applied)	35
6.3. Configuration of channel Unit terminal	18	11. Revision record	36
6.4. How to connect 3 wire type Gas detector	19		
6.5. How to connect 2 wire type Gas detector	19		
7. How to operate Power unit	20		
8. How to operate Common Unit	21		
8.1. Function	21		
8.2. RS485 MODBUS Interface	22		
8.2.1. Communication setting	22		
8.2.2. RS485 MODBUS communication setting and Register	22		

GTC200A Series is ammeter that adopted high-performance A/D Converter and Micro-Process with diversified functions embedded. GTC200A Series is configured in centralized style, comprised of a Common alarm unit and a Multi-Channel control unit for several detectors, with the Multi channel control unit being connected to each detector.

GTC200A Series is protected by the case of DIN Type, and has 2 types of products such as Panel mount type, Wall mount type, etc. GTC200A Series has the display function of FND Digital display (PV Value) and the display function of 3-color LED Bar Graphic display (PV and Alarm set value) embedded, accompanied by 3 Instant alarm functions (1st H/L, 2nd H/L, 3rd H/L) and Trouble alarm.

2. Features

Upon occurrence of Instant alarm and Trouble alarm, GTC200A Series is displayed as Audible(Buzzer) and Visual(Alarm LED and Bar graphic LED flashing), and has Max. PV Value holding functions upon occurrence of an alarm. GTC200A Series allows remote control for alarm clearing, and can perform interlocked control functions as it has the output for alarm (SPDT Contact). Common alarm unit of GTC200A Series is supplying communication output (Isolation type RS-485 : Option) to configure Monitoring system such as Gas vision, etc. while each Channel control unit is supplying outputs for measured values (4~20mA. DC). GTC200A Series is configured with the latest parts, being equipped with stability and reliability, and is capable of the maximum Expansion (Max. 63 channels) in a given space.

3.1. Common Alarm Unit

ITEMS	SPECIFICATION
Input form	RS-485
Input measuring period	100ms
Alarm display	Audio signal- Audible(Buzzer) and Visual signal- Visual(LED)
Alarm clearing	Return switch- Manual (Reset switch)
Control input	Outside input(Remote reset) - Buzzer stop/ return function
Measured output	Isolation RS-485 modbus(Optional)
Alarm output	Buzzer - Buzzer SPST Relay dry contact signal output
	Breakdown alarm - SPDT Relay Dry contact signal output
	1st alarm - Alarm 1 SPDT Relay dry contact signal output
	2nd alarm - Alarm 2 SPDT Relay dry contact signal output
	3rd alarm - Alarm 3 SPDT Relay dry contact signal output
	* Relay dry contact capacity : AC125V 10A
Operation power supply	DC 24V / 100mA Max

■ No. of Channel units for the maximum access to a common unit is 63ea.

3.2. Channel Control Unit

ITEMS	SPECIFICATION	
Input form	Analog 4-20mA	
Measurement display	4-Digit FND & Bar-graph (32 segment, 3-color LED)	
Measuring range	0.000 to 9999 Digital (Arbitrary setting by the user)	
Measuring accuracy	FND Digital	±1% Full Scale
	LED Bar	±1% Full Scale
Input measuring period	100 ms	
Alarm setting	3-stage alarm (Arbitrary setting by the user)	
Alarm setting display	3 Color bar graphic (Green/Red/Yellow LED)	
Alarm display	LED bar graphic	
Alarm clearing	Manual (Common unit)	
Self diagnosis	Test switch & Reset switch	
Control input, output	RS-485	
Measured output	Analog 4-20mA	
Alarm output	Breakdown alarm	SPDT Relay dry contact signal output
	Alarm 1	SPDT Relay dry contact signal output
	Alarm 2	SPDT Relay dry contact signal output
	Alarm 3	SPDT Relay dry contact signal output
	Relay dry contact capacity : AC250V/3A, 30V/3A	
Operation power supply	DC 24V / 100mA Max	

3.3. Power Unit (Option)

ITEMS	SPECIFICATION
Input power supply	DC. 24V
Output power supply	DC. 24V (reserve power supply : DC. 27V / 300mA)
Output power supply display	FND Digital display
Main power supply display	Green LED display
reserve power supply display	Green LED display
reserve power supply monitoring	Red LED display
reserve power supply test	Test switch for preliminary power switch
reserve power supply	Ni-Cd Battery 24V / 600mA(less than 6 circuits)

3.4. Environmental Specifications

ITEMS	SPECIFICATION
Operation Temperature	-20 to 60 °C
Storage Temperature	-20 to 60 °C
Operation Humidity	5 to 99% RH (Non-condensing)
Pressure Range	90 to 110KPa

4. Specifications for Wall Mount product

ITEMS	SPECIFICATION		
Input power supply	AC 110V/220V 50/60Hz (basic AC220V 50/60Hz)		
Specification with SMPS application per Channel (For SMPS specifications of the installed product, checking of specifications for SMPS Inside product is required, since specifications on the right side can be changed upon manufacturing)	Channel configuration	Upon application of 0.5A to detector	Upon application of 0.2A to detector
	3(4) Channel	24V / 3.2A(2.4A)	24V / 1.7A(1.4A)
	5(6) Channel	24V / 4.6A(3.9A)	24V / 2.4A(2.1A)
	7(8) Channel	24V / 6.0A(5.3A)	24V / 3.2A(2.8A)
	9(10) Channel	24V / 7.5A(6.8A)	24V / 3.9A(3.5A)
() is basic applied quantity and capacity for the type with Power unit not applied.			
Alarm display	Audio signal- Audible(Buzzer) and Visual signal- Visual(LED)		
Alarm clearing	Return switch- Manual (Reset switch)		
Control input	Outside input (Remote reset) - Buzzer stop / return function		
Measured output	Isolation RS-485 modbus(Optional)		
Backup power unit(Optional)	24V DC/600mA		
	24V DC/1300mA		
Approval	CE, KR, KFI		

5.1. Configuration and description of power supply unit

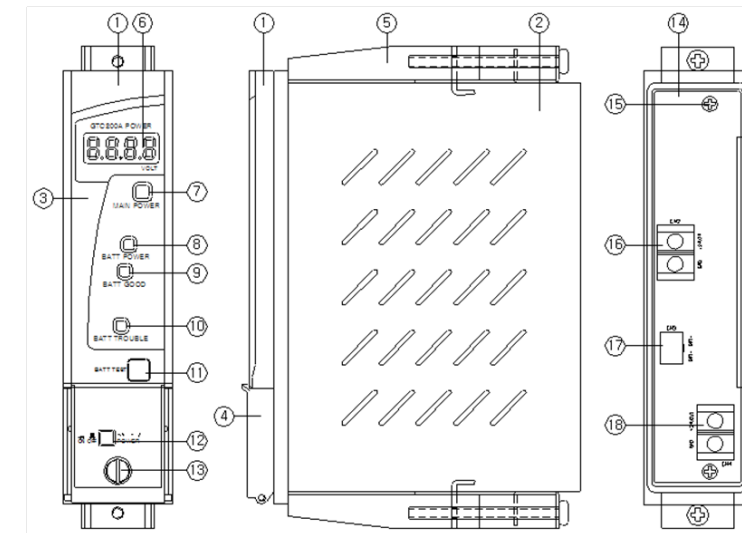

[Figure 1. Configuration of power supply unit]

No	ITEMS	SPECIFICATION
1	Front cover case	Power Unit front-face Cover
2	Main body case	Power Unit main Body
3	Acrylic	Acryl for protection of Power Unit front-face cover
4	Front sub cover	Power Unit front-face Sub cover
5	Main body fixed bracket	Bracket for fixing of Power Unit
6	Main/Battery power display	Main power supply voltage and battery voltage are displayed Voltages of power supply supplied to Common unit and channel unit are displayed
7	Main power LED	LED light for main power supply is turned on when AC power supply is used, while it is turned off when reserve power supply is used
8	Battery power LED	LED for reserve power supply is lighted when reserve power supply is used rather than AC main power supply is used.
9	Battery power good LED	Lighted when voltage of preliminary power voltage is normal above 1.8V after being connected.
10	Battery power trouble LED	Lighted when preliminary voltage is below 18V, and blinks if the reserve power supply was not connected.
11	Battery power test key	It is a switch for testing whether reserve power supply operates normally. While the switch is being pushed, voltage of the reserve power supply is applied to operate the gas leakage alarm. At this time, voltage of the reserve power supply is displayed in FND.

No	ITEMS	SPECIFICATION
12	Battery power ON/OFF switch	on/off switch for preliminary power switch. Note1) It is turned off upon shipment of product Note2) The preliminary power switch should be turned on after main power supply is turned on.
13	Front cover screw	Screw for fixing of Power Unit
14	Terminal PCB	Power Unit Terminal PCB
15	Terminal PCB screw	Screw for fixing of Power Unit Terminal PCB
16	DC input connector	Input connector for power supply of Power Unit
17	Battery connector	Input connector for reserve power supply of Power Unit
18	DC output connector	Voltage output connector for operation of channel card

[Table 1. Description on configuration of power supply unit]

5.2. Configuration and description of alarm unit (Common unit)

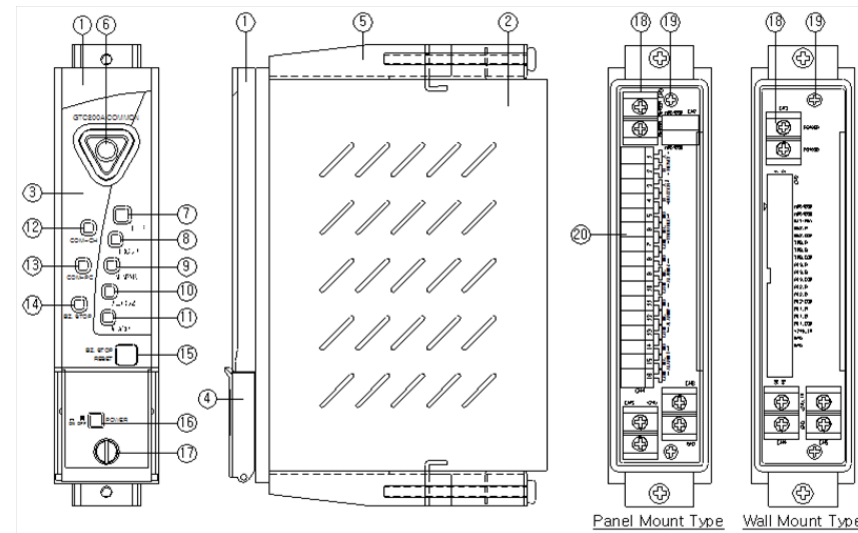

[Figure 2. Configuration and description of alarm unit]

NO	NAME	DESCRIPTIONS
1	Front cover case	Front-face Cover for Common unit
2	Main body case	Front-face main Body for Common unit
3	Acrylic	Acryl for protection of front-face cover for Common unit front-face
4	Front SUB cover	Front-face Sub cover for Common unit front-face
5	Main body fixed bracket	Bracket for fixing of Common unit
6	Buzzer	Operates as intermittent sound of each upon occurrence of Alarm and trouble in each channel.
7	Power LED	Power LED is lighted when power is inputted in Common unit
8	Trouble LED	Trouble LED is lighted when trouble occurred in each channel unit. Ex) Upon occurrence of defective wire connection with detector and of abnormality
9	Alarm-3 LED	Alarm 3 LED is lighted upon occurrence of the 3rd alarm in each channel unit. Alarm 3 LED is lighted when the 3rd alarm value is reached upon execution of test functions in each channel
10	Alarm-2 LED	Alarm 2 LED is lighted upon occurrence of the 2nd alarm in each channel unit. Alarm 2 LED is lighted when the 2nd alarm value is reached upon execution of test functions in each channel.
11	Alarm-1 LED	Alarm 1 LED is lighted upon occurrence of the 1st alarm in each channel unit. Alarm 1 LED is lighted when the 1st alarm value is reached upon execution of test functions in each channel.
12	Communication LED (Channel)	Normal communication is realized with entire channel units set in Common unit, COM-CH LED continues to be lighted, while COM-CH LE blinks when there is a Channel unit without realization of communication. (When No. of Channel units is set as less than 1 ea. In Common unit, it blinks at an interval of 0.5sec.)
13	Communication LED (PC)	When communication DATA transmitted from PC is normally received in Common unit, COM-PC LED is immediately turned off after being lighted once. (When Common unit address is set as less than 1ea. In Common unit, it blinks at an interval of 0.5sec.)
14	Buzzer stop LED	As an alarm occurs in Channel unit, buzzer operates, and buzzer stops when Buzzer stop switch is pushed. At this time, BZ-STOP LED is lighted, When Buzzer stop switch is pushed once more in Common unit or Channel unit, BZ-STOP LED is turned Off. (However, it is lighted only when Alarm type was set as hold in Channel unit
15	Buzzer Stop/Reset key	It is the key used for Buzzer stop and Reset when Trouble and Alarm occurred in each channel unit. Push once initially.... Buzzer sound is stopped and BZ-STOP LED is lighted. Push twice consecutively.... As BZ-STOP LED is turned Off, Reset function of all channel units in Latch state according to Alarm setting is executed.
16	Power ON/OFF switch	Power ON/OFF switch for Common unit .
17	Front cover screw	Screw for fixing of Common unit
18	Terminal PCB	Common Unit Terminal PCB
19	Terminal PCB screw	Screw for fixing of Common Unit Terminal PCB
20	Connector	Input connector for signals

[Table 2. Description on configuration of alarm unit]

5.3. Configuration and description of concentration display unit (Channel unit)

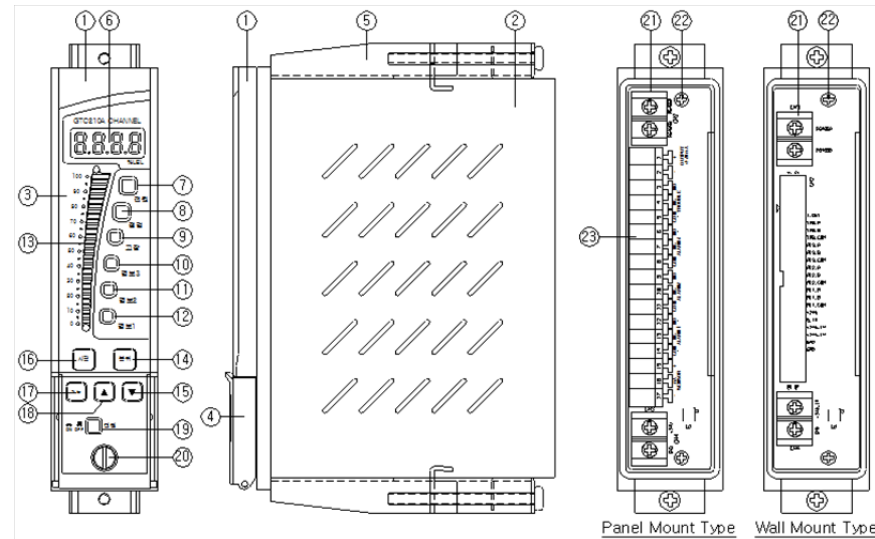

[Figure 3. Components of channel unit]

NO	NAME	DESCRIPTIONS
1	Front cover case	Front-face Cover for Channel control unit
2	Main body case	Main Body for Channel control unit
3	Acrylic	Acryl for protection of front-face cover for Channel control unit
4	Front sub cover	Front-face Sub cover for Channel control unit
5	Main body fixed bracket	Bracket for fixing of Channel control unit
6	FND display	Measured values of detector connected to each channel are continuously displayed, and user designated values are displayed in blinking state upon execution of test function.
7	Power LED	When Power is Inputted in Channel unit, Power LED is lighted.
8	Check LED	STD-BY LED blinks in the case of detector checkup mode.
9	Trouble LED	Trouble LED is lighted when trouble occurs in channel unit and detection unit. Ex) When defective wire connection with detector and abnormality occur
10	Alarm-3 LED	Alarm 3 LED is lighted when the 3rd alarm occurs in channel unit. Alarm 3 LED is lighted when the 3rd warning value is reached upon execution of test function of the channel unit.

NO	NAME	DESCRIPTIONS
11	Alarm-2 LED	Alarm 2LED is lighted when the 2nd alarm occurs in channel unit. Alarm 2 LED is lighted when the 2nd warning value is reached upon execution of test function of the channel unit.
12	Alarm-1 LED	Alarm 1 LED is lighted when the 1st alarm occurs in channel unit. Alarm 1 LED is lighted when the 1st warning value is reached upon execution of test function of the channel unit.
13	3 color bar graphic LED	3 Color bar graphic LED continuously shows, display of measured value and of alarm setting value as in FND display. Bar graphic LED is lighted as green when the measured value is less than the 1st alarm, as orange when it is more than the 1st alarm and less than the 2nd alarm, as red when it is more than the 2nd alarm. When the measured value is more than the alarm setting value, Bar graphic is held at the highest value, and Bar graphic is displayed in blinking state for the alarm.
14	Reset key	It performs functions such as Alarm clearing of Channel unit, clearing of Self test, clearing of Program setting, etc.
15	Down key	After selection of each mode using Func.key, arbitrary values can be selected by using "▲", "▼" Key. When "▲", "▼" Key is pushed for a given time in the mode requiring frequent changes of setting values, the setting values are changed fast.
16	Test key	When Test switch is pushed, the mode executing self diagnosis function is entered into. It is the key where the measured value FND blinks, checking of Alarm operation state in Channel unit and Common unit by adjustment of blinking measured values is possible by using "▲" key or "▼" key. For clearing of diagnosis, clearing occurs by pushing once the Reset key in each Channel unit.
17	Function key	Function key is the key that inputs data values by conversion and selection of functions such as setting of warning values. Setting of alarm method, setting of Dead band for alarm, etc.
18	Up key	After selection of each mode using Func.key, arbitrary values can be selected by using "▲", "▼" Key. When "▲", "▼" Key is pushed for a given time in the mode requiring frequent changes of setting values, the setting values are changed fast.
19	Power ON/OFF switch	Power ON/OFF switch for Channel unit.
20	Front cover screw	Screw for fixing of Channel unit
21	Terminal PCB	Channel Unit Terminal PCB
22	Terminal PCB screw	Screw for fixing of Channel Unit Terminal PCB
23	Connector	Output connector for signals

[Table 3. Description on components of channel unit]

5.4. Configuration and description of Wall mount type

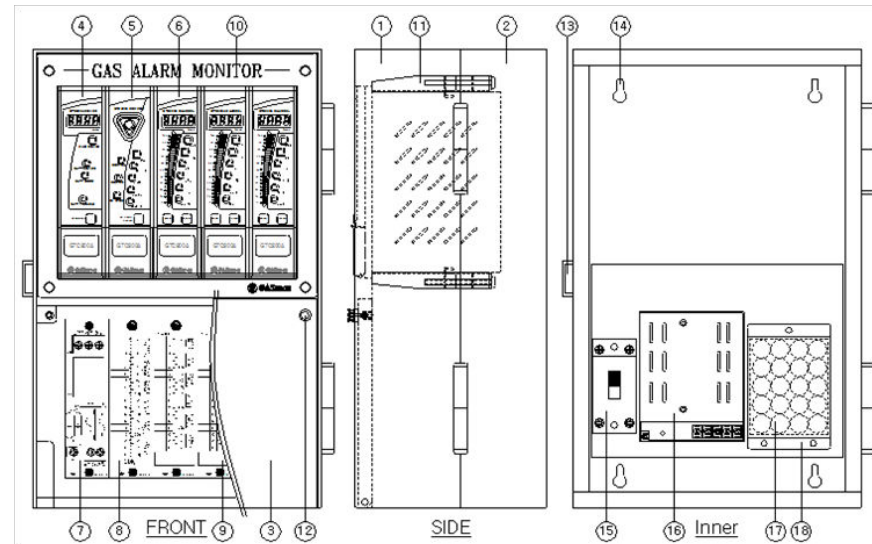

[Table 4. Components of wall mount]

NO	NAME	DESCRIPTIONS
13	Front case fixed hook	Hook for fixing of front-face case cover
14	Wall mount fixed hole	Hole for fixing of Wall mount Type
15	Main power switch	Power supply switch of Wall mount Type
16	Power supply	Power supply device
17	Battery (option)	Battery for reserve power supply
18	Battery cover (option)	Battery Cover for reserve power supply

[Table 5. Description on components of wall mount]

NO	NAME	DESCRIPTIONS
1	Wall mount case front	Front-face case of Wall mount Type
2	Wall mount case rear	Rear-face case of Wall mount Type
3	Wall mount case cover	Terminal cover of Wall mount Type
4	Power unit (option)	Unit used upon using reserve power supply (Battery), being provided as an Option.
5	Common unit	Common Unit displaying control and alarm signals of channel unit
6	Channel unit	Channel Unit displaying the measured values by being connected with detection unit
7	Mother board filter PCB (option)	PCB applied and mounted only upon use of Power unit, protecting the circuit from electromagnetic waves, noise, surge, etc.
8	Mother board common PCB	Output terminal for relay contact such as buzzer, breakdown, alarm, etc. is provided
9	Mother board channel PCB	Connection for detection unit as well as output terminal for current of 4~20mA and output terminal for relay contact such as alarm etc. are provided.
10	Name plate	Product name of Wall mount Type is displayed
11	DIN case fixed bracket	Bracket for fixing of individual cards
12	Case cover screw	Screw for fixing of terminal cover

6.1. Power supply and signal configuration for Channel Unit

- Configurations of channel Unit, Common Unit and power Unit are as shown in the following figure, where the channel unit allows configuration of 63 ea.

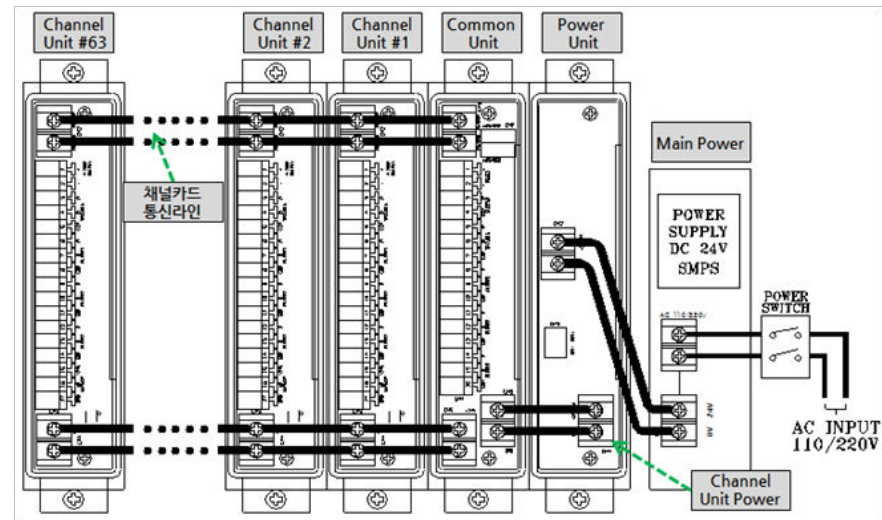

[Figure 4. Power supply and signal configuration for channel card]

- Power unit is mounted only when the reserve power supply (Battery) is used.
- When the Power unit is not used, DC24V is directly connected to Connector(CN6) of Common unit in Power supply for use. (Power unit is provided as an option.)

6.2. Configuration of power supply for Wall Mount Type

- Unfasten the fixing chain for front case on the left side of Wall mount, and open the front case to input power supply in the circuit breaker for wiring positioned on the bottom left side inside the case.
- Power supply in use is AC110V or 220V, and is set and released for the voltage in use requested upon product ordering, and shipped by being set at AC220V unless there is a separate request.

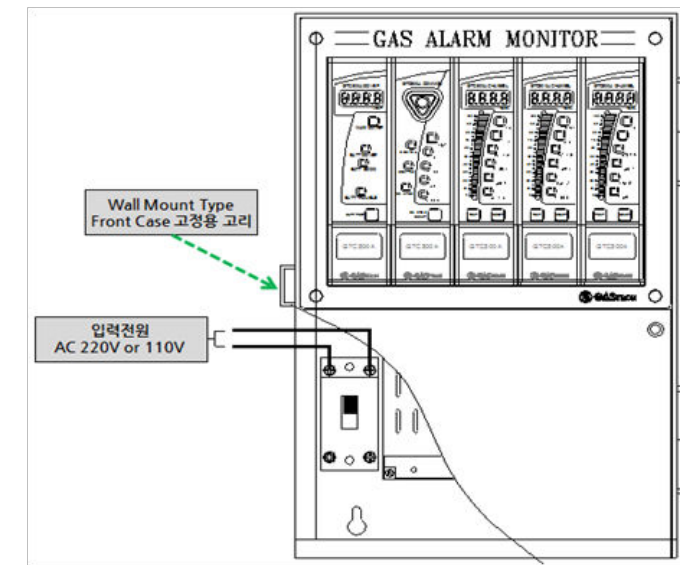

[Figure 5. Configuration of power supply for Wall Mount]

6.3. Configuration of channel Unit terminal

NO	NAME	DESCRIPTIONS
1	Output 4-20mA +	4-20mA output of measured values for detection unit
2	Output 4-20mA -	
3	TROUBLE RELAY NO	Output Relay for breakdown state
4	TROUBLE RELAY NC	
5	TROUBLE RELAY COM	
6	Warning3 RELAY NO	Output Relay for 3rd alarm
7	Warning3 RELAY NC	
8	Warning3 RELAY COM	
9	Warning2 RELAY NO	Output Relay for 2nd alarm
10	Warning2 RELAY NC	
11	Warning2 RELAY COM	
12	Warning1 RELAY NO	Output Relay for 1st alarm
13	Warning1 RELAY NC	
14	Warning1 RELAY COM	
15	Detector Power Supply +	Supply power to detection unit and input 4-20mA signals
16	Detector 4-20mA Input	
17	Detector Power Supply -	

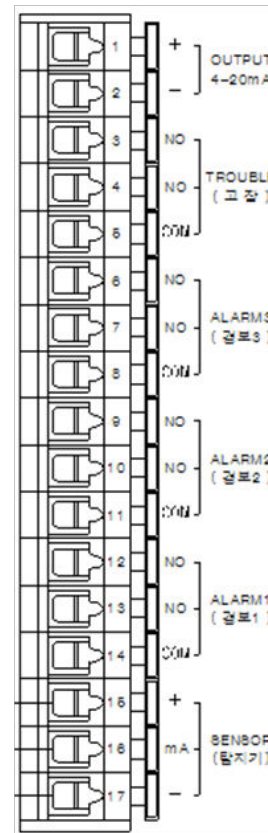

[Figure 6. Configuration of Channel Unit terminal]

6.4. How to connect 3-wire type Gas detector

- When power supply for gas detector and 4-20mA output are configured as 3-wire (V+, mA, V-), connect to the Channel Unit by the following method.
- Connecting cable should be configured with shield cable of CVVS or more than CVVSB.

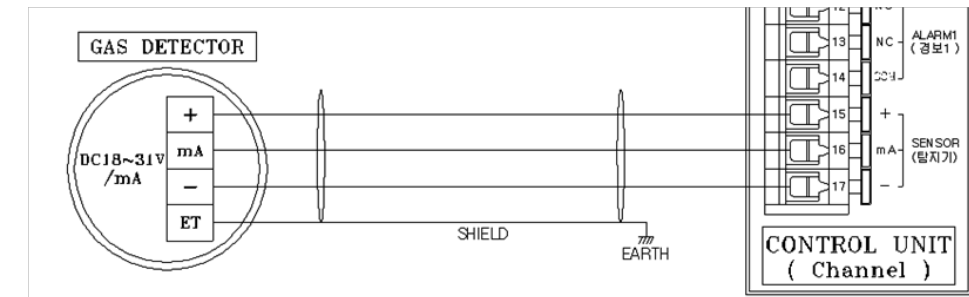

[Figure 7. Connection method for 3-wire gas detector]

- Our company's detector models of the relevant method include TS-1100Ex, TS-2000Ex, TS-2100 Series, TS-4000 Series, TS-4100P Series, TS-5100 Series, GTD-1000 Series, GTD-2000 Series, GTD-3000 Series, and GIR-3000 Series.

6.5. How to connect 2-wire type Gas detector

- When the output for gas detector is configured with 2-wires (V+, V-), connect to the Channel Unit by the following method.
- Connecting cable should be configured with shield cable of CVVS or more than CVVSB 1.5sq.

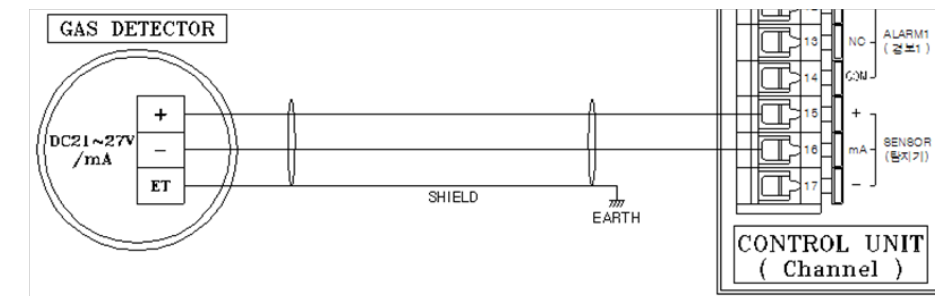

[Figure 8. Connection method for 2-wire 3 gas detector]

- Our company's detector models of the relevant method include TS-1100Tx, TS-2000Tx, TS-3000 Series, and TS-3100 Series.

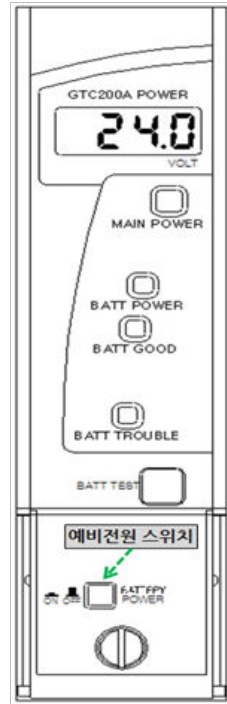

- Voltage of the main power supply is displayed by figures in FND Digital display.
- When the checkup key for reserve power supply is pushed, the power supply is converted to the reserve power supply, the voltage of which is displayed by figures in FND Digital display.
- When the reserve power supply is not connected, the breakdown LED for reserve power supply blinks at an interval of 0.5 sec.
- When the reserve power supply is more than 18V, the normal LED for reserve power supply is lighted, while the breakdown LED for reserve power supply is lighted when it is less than 18V.

Note1) It is turned off upon shipment of product.

Note2) Turn on the switch for reserve power supply after turning on the main power supply.

8.1. Functions

NO	FUNCTION	DESCRIPTION
1	Buzzer alarm	When breakdown signals are sent from the Channel unit, alarm sound occurs as a short intermittent sound. When alarm signals are sent from the Channel unit, alarm sound occurs as a long intermittent sound.
2	Breakdown/alarm LED	It is an LED lighted when breakdown signals or alarm signals are sent from the Channel unit, where the alarm LED blinks during alarm maintenance time.
3	Communication LED	COM-CH LED shows a state of communication between Common unit and Channel unit, and is turned off after being lighted for about 0.1 sec upon communication once. Thus, when normal communication occurs as many as the No. of channel units set in the Common unit, continuously lighted state is maintained (Channel unit access time is 0.1sec). When communication DATA transmitted from PC is normally received in the Common unit, COM-PC LED is immediately turned off after being lighted once. When SW1 and SW2 are set in the Common unit as less than 1 ea. 1it blinks at an interval of 0.5 sec(COM-CH/ COM-PC LED).
4	Buzzer-Stop LED	As an alarm occurs in the Channel unit, buzzer operates. When Buzzer stop switch is pushed. The buzzer is stopped, at which time BZ-STOP LED is lighted (However, it is lighted only when Alarm type was set as hold in the Channel unit). When the Buzzer stop switch is pushed once more in Common unit or channel unit, BZ-STOP LED is turned Off.
5	Buzzer stop and Reset key	It is a key used for Buzzer Stop and Reset when Trouble and Alarm occurs in each Channel unit. Push once initially.... Buzzer sound is stopped and BZ-STOP LED is lighted. Push twice consecutively.... As BZ-STOP LED is turned Off Reset function of all channel units in Latch state according to Alarm setting is executed.

8.2. RS485 MODBUS Interface

8.2.1. Setting for communication

- Baud rate : 9600BPS
- Stop bit : 1 Stop
- Parity : Even parity

8.2.2. Setting for RS485 MODBUS communication and Register

- Concentration value for Channel unit (Analog input)

NO	FUNCTION NAME	ADDRESS	OTHER
1	Concentration value for Channel-1 unit	30001	Address increased by 1 at each time per Channel unit.
2	Concentration value for Channel-2 unit	30002	
n	Concentration value for Channel-n unit	30xxx	

[Table 6. Register of concentration values for channel Unit RS485]

- Bit data for Channel unit state (Data for reading of data input contact)

NO	FUNCTION NAME	ADDRESS	OTHER
Channel-1 unit	State data for Alarm1	10001	8Bit each assigned per 1 Channel unit
	State data for Alarm2	10002	
	State data for Alarm3	10003	
	State data for breakdown	10004	
	State data for checkup	10005	
	Preliminary data	10006~10008	
Channel-2 unit	State data for Alarm1	10009	8Bit each assigned per 1 Channel unit
	State data for Alarm2	10010	
	State data for Alarm3	10011	
	State data for breakdown	10012	
	State data for checkup	10013	
	Preliminary data	10014~10016	
Channel-n unit	State data	10001+((n-1)*8) ~ 10001+(((n-1)*8)+8)	

[Table 7. Register of state for channel Unit RS485]

9.1. Power ON

- Check wire connections of operation power supply, with detection unit, between alarm unit and channel unit.
- Turn ON the power supply switch after checking input power supply.
- Check that "SELF" is displayed in FND.

When the power supply is turned ON for Channel unit, "SELF" blinks in FND of the channel unit for 15sec, and breakdown alarm occurs when abnormality occurs in detection unit.

9.2. Gas Measuring Mode

- When there is no abnormality in SELF TEST after Power ON, the following gas measuring state is automatically entered into.

- Gas concentration value received from the detector is displayed as figures in FND Digital display.
- 3 Color Bar graphic LED displays gas concentration, in green when the concentration is less than the 1st Alarm, in orange when it is more than the 1st Alarm and less than the 2nd Alarm, and in red when it is more than the 2nd Alarm.
- The setting value for the stage 3 Alarm is constantly displayed by 3 Color bar graphic LED, in green for the 1st Alarm value, in orange for the 2nd Alarm value, and in red for the 3rd Alarm value.

- When the detector is not connected or has abnormality, the characters of "Undr" are displayed by blinking at an interval of about 0.5 sec.
- Trouble LED lamp is lighted.
- Circular LED at the most bottom among 3 Color bar graphic LED is lighted in red.

- When the current value inputted from the detector is higher than the set High Scale by 10%, the text of "ouEr" is displayed by blinking at an interval of 0.5 sec.
- Circular LED on the topmost among 3 Color bar graphic LED's is lighter in red.
- When the gas concentration value is recognized to be more than the Alarm setting value, the relevant Alarm function counts the alarm maintenance time so that Alarm function is operated if it is more than the Alarm maintenance time.
- While the Alarm maintenance time is being counted Alarm LED Lamp blinks at an interval of 0.5sec, and is lighted when it becomes more than the Alarm maintenance time.
- Alarm relay is turned ON after more than the Alarm maintenance time is elapsed.
- If the Alarm latch type is in "on" mode, Alarm state and gas concentration value are maintained at the maximum value when Alarm function is operated, and is not cleared even though the gas concentration falls below the Alarm value, and must always be cleared by using "Reset" key.
- When the Alarm latch type is in "off" mode, the Alarm function is automatically cleared according to gas concentrations.

9.3. Test Mode

- When there is no abnormality in SELF TEST after Power On, the following state of gas measurement is automatically entered into.

	<ul style="list-style-type: none"> - When "Test" key is pushed for more than 2sec in the display state of gas concentration, Test mode is entered into. - When 30 min is elapsed in the Test mod after the last key operation, the display state for gas concentration is automatically returned to.
	<ul style="list-style-type: none"> - It is a function allowing test in the Channel unit without injection of detector sensor gas while the figure of gas concentration is displayed by blinking upon entering into the Test mode. When the user pushes "▲" key or "▼" key, an arbitrary gas concentration value can be set, and the Alarm function is normally operated with the concentration value designated by the user. - When "Func" key is pushed for more than 2sec, FND/LED/Bar LED test function is entered into. - When "Reset" key is pushed, the concentration display mode is returned to.
	<ul style="list-style-type: none"> - It is the Test mode for FND/LED/Bar LED, where FND figure is displayed as 4-digit figure and overall display (8888) are displayed at an interval of 0.5 sec, and 4-digit figure displays setting values for PC Add(SW1) and CH CNT(SW2) of the Common unit. - 3 Color bar graphic LED alternately displays green, orange and red at an interval of 0.5sec, and each function LED blinks at an interval of 0.5sec. - When "Func" key is pushed, the mode where normal operation of communication of Channel unit with Common unit is checked is entered into. - When "Reset" key is pushed, the concentration display mode is returned to.
	<ul style="list-style-type: none"> - It is the mode for checking of Channel unit where communication with Common unit is normally operated, and the No. of Channel unit where normal communication is realized is sequentially displayed at an interval of 0.5sec. - If there is a channel unit No. where all of the No. of Channel units set in Common unit is not displayed and omitted, it becomes a Channel unit with no communication. - When "Func" key is pushed, the gas concentration Test function is returned to. - When "Reset" key is pushed, the concentration display mode is returned to.

9.4. Checkup mode (Stand-by Mode)

	<ul style="list-style-type: none"> - When "▼(Standby)" key of Channel unit is pushed for more than 2sec in the display state of gas concentration, the checkup mode is entered into. - In checkup mode, The checkup mode is cleared and the display state of gas concentration is returned to only when "▼(Standby)" key is pushed in Channel unit. - In the locking mode, It is a mode where all remaining functions operate as STD-BY LED blinks while output of Trouble/Alarm relay contact for Common unit and Channel unit does not operate. - When "▼(Standby)" key is pushed, the concentration display mode is returned to.
--	---

9.5. Setting for operation

9.5.1. PROGRAM MODE





	<ul style="list-style-type: none"> - When "▲", "▼" keys are simultaneously pushed for more than 2sec in the display state of gas concentration. - When 10sec passes after the last key operation in program setting function, the display state of gas concentration is returned to.
	<ul style="list-style-type: none"> - The setting message for position of decimal point as the 1st function of setting functions for program data is displayed as "dP-S". - When "Func" key is pushed, the setting function for decimal point is entered into. - When "Reset" key is pushed, the concentration display mode is returned to.
	<ul style="list-style-type: none"> - Decimal point is sued when there is a need for change according to the measuring range. When position of the decimal point is set, position of the decimal point is changed to 3 types as shown on the left side whenever "▲" key or "▼" key is pushed. - If "FUNC" is pushed when the desired position of decimal point is displayed, the position of the decimal point is set and the next item is entered into. - When "Reset" key is pushed, the concentration display mode is returned to.
	<ul style="list-style-type: none"> - The message for setting of High scale as a function for setting the maximum value of gas concentration display is displayed as "H-SL". - When "Func" key is pushed, the setting function for High scale is entered into. - When "Reset" key is pushed,, the concentration display mode is returned to. - High scale value is set for the range specified by domestic regulations upon product shipment.
	<ul style="list-style-type: none"> - The setting value for High scale value can be changed according to the measuring range, and the Scale value is increased or decreased whenever "▲" key or "▼" key is pushed. - If "FUNC" is pushed when the desired High scale value is displayed, the High scale value is set and the next item is entered into. When "Reset" key is pushed, the concentration display mode is returned to. - The present setting mode shall be set for the same measuring range as detection unit upon factory shipment. <p>Ex) When Range was set for 100 Upon inputting of 4 mA.DC..... 0 Display Upon inputting of 20 mA.DC..... 100 Display</p>



SAd	<ul style="list-style-type: none"> - The message for setting function of SAD value as a function to compensate errors for measured values occurring in detection unit is displayed as "SAd". - When "Func" key is pushed, the setting function for SAD value is entered into. - When "Reset" key is pushed, the concentration display mode is returned to.
0	<ul style="list-style-type: none"> - It is a function for setting of SAD value, and the SAD value is increased or decreased whenever "▲" key or "▼" key is pushed. In the case of negative (minus) value, "-" symbol is displayed by being added onto the first figure.
- 1	<ul style="list-style-type: none"> - If "FUNC" key is pushed when the desired SAD value is displayed, the SAD value is set, and the next item is entered into. - When "Reset" key is set, the concentration display mode is returned to. Ex) When SAD was set as 2: When the output error in detector is -2, Display displays the SAD setting value as 0 after calibration of 2, although actual display should indicate -2.
CHno	<ul style="list-style-type: none"> - The message for setting of Channel number as a function for setting of recognition No. of Channel unit is displayed as "CHno". - When "Func" key is pushed, the setting function for Channel number is entered into. - When "Reset" key is pushed, the concentration display mode is returned to.
1	<ul style="list-style-type: none"> - Channel No is a mode where Channel unit address is inputted so that operation situation of each Channel unit can be checked, and Address NO.value is increased or decreased whenever "▲" key or "▼" key is pushed. - If "FUNC" is pushed when the desired Address NO is displayed, the Address NO value is set and Alarm reset type function as the next item is entered into. - When "Reset" key is pushed, the concentration display mode is returned to. Note1) Unless Channel No.is inputted, communication between Channel unit and common unit does not occur Note2) For Channel No, mutually different numbers should always be inputted.

9.6. ALARM Mode

- When "Func" key is pushed for more than 2sec in the display state of gas concentration, the setting function for alarm value data is entered into.
- When 10sec passes after the last key operation in the setting function for alarm value, the display state for gas concentration is automatically returned to.

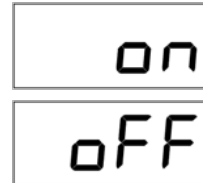

LACH	<ul style="list-style-type: none"> - The message for setting function of Alarm latch type as a function for setting of Alarm latch type is displayed as "LACH". - When "Func" key is pushed, the setting function for Alarm latch type is entered into. - When "Reset" key is set, the concentration display mode is returned to.
on	<ul style="list-style-type: none"> - It is a mode for changing Alarm reset type, where "on" and "off" modes are changed whenever "▲" key or "▼" key is pushed. - If "FUNC" key is pushed when the desired Alarm latch type is displayed, the Alarm latch type is set and the next item is entered into.
off	<ul style="list-style-type: none"> - When "Reset" key is pushed, the concentration display mode is returned to. - Alarm latch type has 2 modes of "on" and "off", where the Alarm is automatically Reset in OFF mode while Alarm is reset only when the user makes sure to push Reset key for clearing.
AL-1	<ul style="list-style-type: none"> - The message for setting function of Alarm1 value as a function for setting of Alarm 1 value is displayed as "AL-1". - When "Func" key is pushed. The setting function for Alarm1 value is entered into. - When "RESET" key is pushed, the concentration display mode is returned to. - Alarm level is set for the concentration specified by domestic regulations upon product shipment.
1	<ul style="list-style-type: none"> - It is a function for changing the setting value for Alarm1, where the maximum values is possible up to the High scale value, and the Alarm value is increased or decreased whenever "▲" key or "▼" key is pushed.
▼▲ Full Range	<ul style="list-style-type: none"> - If "FUNC" is pushed when the desired Alarm 1 value is displayed, the Alarm1 value is set and the next item is entered into. - When "RESET" key is pushed, the concentration display mode is returned to.
1H	<ul style="list-style-type: none"> - It is a mode for setting the direction for operation of Alarm1, where "1H" or "1L" is displayed whenever "▲" key or "▼" key is pushed. - "1H" mode is the mode operating when it is larger than or the same as the setting value for Alarm1, while "1L" mode is the mode operating when it is smaller than or the same as the setting value for Alarm1.
1L	<ul style="list-style-type: none"> - If "FUNC" key is pushed when the desired mode is displayed the mode is set and the next item is entered into. - When "Reset" key is pushed, the concentration display mode is returned to. - Alarm type has flammability set upon factory shipment as 1H and 2H and 3H / oxygen: 3H and 2L and 1L / toxicity: 1H and 2H and 3H Type.

	<ul style="list-style-type: none"> - It is a mode for setting Dead band value for operation of Alarm1, and the value is increased or decreased whenever "▲"key or "▼" key is pushed. - When Alarm1 is in "1H " mode, Alarm 1 operates below the Alarm 1 value minus Dead band value, while Alarm1 is cleared above the Alarm 1 value plus Dead band value when it is in "1L" mode . - If "FUNC" key is pushed when the desired value of Alarm1 Dead band is displayed, the value of Alarm1 Dead band is set and the next item is entered into. - When "Reset" key is pushed, the concentration display mode is returned to. - As the concentration value is reached near the setting value for Alarm, Alarm continues On/Off. This function is a function for giving hysteresis value to remove such phenomenon, and it is set for 0 upon factory shipment. - Ex) When the alarm setting value is 20%LEL / Dead band: 2%LEL, the alarm occurs at 22% LEL based on 20%LEL, and is cleared at 18%LEL.
	<ul style="list-style-type: none"> - The message for setting of Alarm 1 delay time as the function for setting of Alarm 1 delay time is displayed as "AL1t". - If "Func" key is pushed, the setting function for Alarm1 delay time is entered into. - When "RESET" key is pushed, the concentration display mode is returned to.
	<ul style="list-style-type: none"> - It is a function to prevent occurrence of instantaneous malfunction in detector due to external impact and effects of noise rather than normal operation, and Alarm 1 delay time is increased or decreased by the unit of second whenever "▲" key or "▼" key is pushed. - "FUNC" key is pushed when the desired Alarm 1delay time is displayed, the Alarm1 delay time is set and the next item is entered into. - When "Reset" key is pushed, the concentration display mode is returned to. - Ex) The alarm based on 20%LE occurs when the measured value of more than the alarm setting value exists for more than 5 sec in the case of Alarm setting value: 20% LEL / Delay time: 5 sec, while the alarm does not occur when the value is lowered below the alarm setting value within 5 Sec.
	<ul style="list-style-type: none"> - The message for setting of Alarm1 contact output as a function for setting Alarm 1 contact output is displayed as "A1rL". - When "Func" key is pushed, the setting function for Alarm1 contact output is entered into.. - When "Reset" key is pushed, the concentration display mode is returned to.
	<ul style="list-style-type: none"> - It is a mode to change Alarm1 contact output, where " on "and "oFF" modes are changed whenever "▲ key or "▼" key is pushed. - If "FUNC" key is pushed when the desired mode for Alarm 1 contact output is displayed, the mode for Alarm1 contact output is set and the next item is entered into. - When "Reset" key is pushed, the concentration display mode is returned to. - Alarm1 contact output has 2 modes of " on" and "oFF" where Alarm1 contact output does not operated in oFF mode and is operated in on mode.



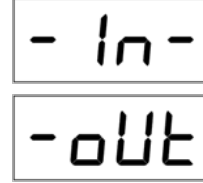

	<ul style="list-style-type: none"> - The message for setting function of Alarm1 blink output as a function for setting of ON/OFF function for Alarm1 contact output at an interval of 1 sec while the buzzer is operating is displayed as "A1bL". - When "Func" key is pushed, the setting function for Alarm1 blink output is entered into. - When "RESET" key is pushed, the concentration display mode is returned to.
	<ul style="list-style-type: none"> - It is a mode to change the Alarm1 blink output, where " on"과 " oFF" modes are changed whenever "▲" key or "▼" key is pushed. - If "FUNC" key is pushed when the desired mode of Alarm1 blink output is displayed, the mode of Alarm1 blink output is set and the next item is entered into. - When "Reset" key is pushed, the concentration display mode is returned to. - Alarm1 blink output has 2 modes of " on" and " oFF" , where Alarm1 blink output is not operated in oFF mode while Alarm1 blink output is operated in on mode. (However, it is operated when the mode of Alarm1 contact output is on.) - Both the 2nd alarm(Alarm2) and the 3rd alarm (Alarm3) have the same menu structure.
	<ul style="list-style-type: none"> - The message informing completion of setting function is displayed as "End" for 2sec, and the display state of gas concentration is returned to.

■ Both the 2nd alarm and the 3rd alarm have the same menu structure.

9.7. Maintenance Mode

	<ul style="list-style-type: none"> - When "TEST" and "RESET" keys are simultaneously pushed as "SELF" is blinking after power supply ON, the setting function for Maintenance is entered into. - When "Reset" key is surely pushed in Maintenance mode, the display state for gas concentration is returned to.
	<ul style="list-style-type: none"> - It is a mode for selecting the function to set current input value and output value as the reference for Alarm - Channel unit, and ""-In-"or "-oUt" is displayed whenever "▲" key or "▼" key is pushed. - If "FUNC" is pushed when the desired mode is displayed, the relevant mode is entered into. - When "-In-" was selected, we have the mode for setting current input value, while it is mode for setting current output value when "-oUt" was selected. - When "Reset" key is pushed, the concentration display mode is returned to.
	<ul style="list-style-type: none"> - It is the case where "-In-"was selected, as a mode for setting by inputting 20mA current, and the message is displayed as "IA20". - When "Func" key is pushed, the function for displaying current input value as figures is entered into. - When "Reset" key is pushed, the concentration display mode is returned to.

9. How to operate Channel Unit

	<ul style="list-style-type: none"> - It is a mode where the value transformed in the process is displayed by figures after inputting 20mA current in (mA) terminal. - "Func" key is pushed when the displayed figures re stable, the input value for current is set, and the next item is entered into. - When "Reset" key is pushed, the concentration display mode is returned to.
	<ul style="list-style-type: none"> - It is the case of selecting "-Out" and the next mode after input current. It is the mode for setting of 4mA output current, 7 the message is displayed as "A-04". - If "Func" key is pushed when the ammeter accurately displays 4mA by pushing "▲" key or "▼" key while watching the ammeter after connecting the ammeter to output terminal of 4~20mA, the output current value is set and the next item is entered into. - When "RESET" key is pushed, the concentration display mode is returned to.
	<ul style="list-style-type: none"> - It is a mode for setting 20mA output current, and the message is displayed as "A-20". - If "Func" key is pushed when the ammeter accurately displays 4mA by pushing "▲" key or "▼" key while watching the ammeter after connecting the ammeter to output terminal of 4~20mA, the output current value is set and the next item is entered into. - When "RESET" key is pushed, the concentration display mode is returned to.
	<ul style="list-style-type: none"> - The message informing completion of the setting function is displayed as "End" for 2sec, 7 the concentration display mode is returned to.

10. Outline drawing and Dimensions

10.1. Power unit

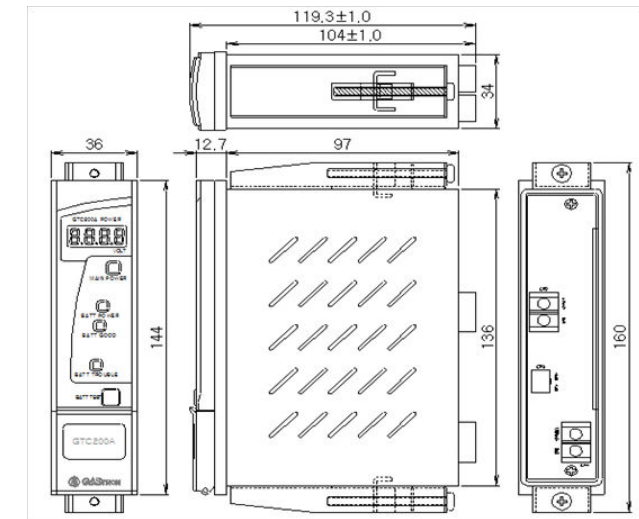

[Figure 9. Outline drawing of Power Unit]

10.2. Common Unit

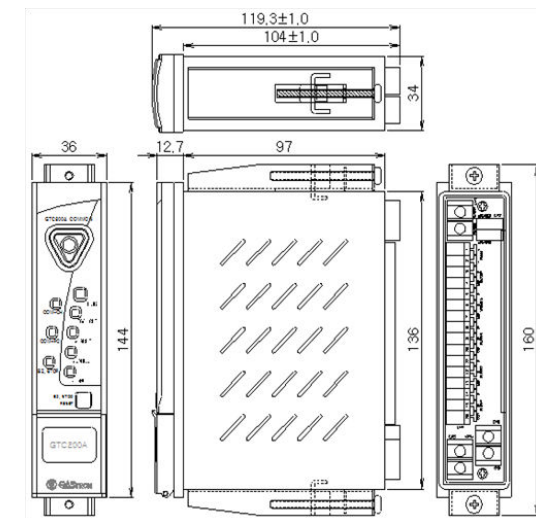

[Figure 10. Outline drawing of Common Unit]

10.3. Channel Unit

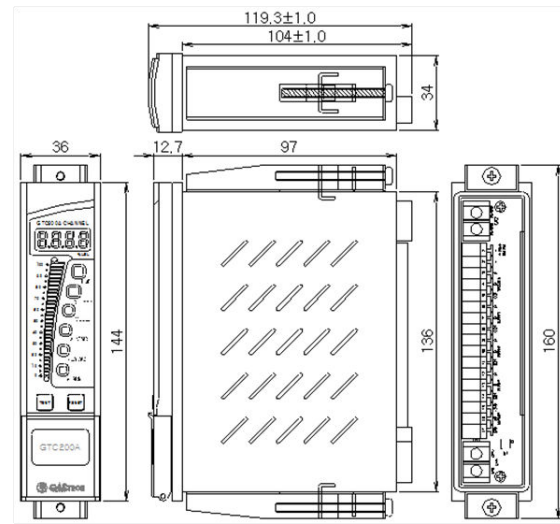

[Figure 11. Outline drawing of Channel Unit]

10.4. Panel mount type

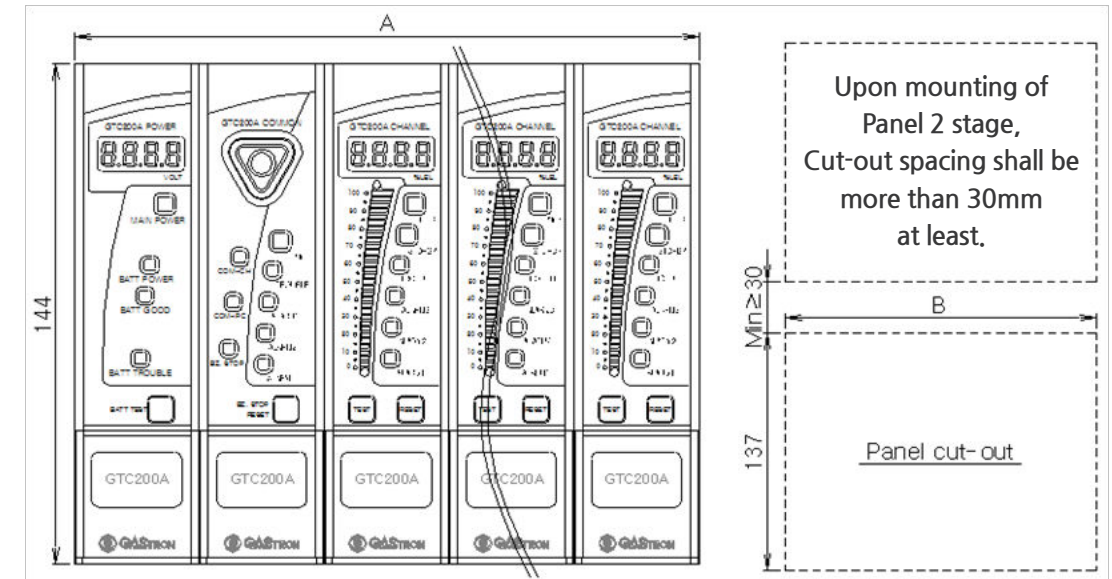

[Figure 12. Outline drawing of Panel mount]

CHANNEL	A(MM)	B(MM)	CHANNEL	A(MM)	B(MM)
1 Channel	108	107	6 Channel	288	287
2 Channel	144	143	7 Channel	324	323
3 Channel	180	179	8 Channel	360	359
4 Channel	216	215	9 Channel	396	395
5 Channel	252	251	10 Channel	432	431

Power Unit is optional, and the width of 36mm for Power unit should be subtracted from the above dimension when only Common unit and Channel unit are used.

Ex) When Power unit is not used in the case of 5 Channel, A is 216mm(252mm-36mm), and B becomes 215mm(251mm-36mm)

[Table 8. Dimension according to setting for Panel Mount channel]

10.5. Wall mount type(Power Unit applied)

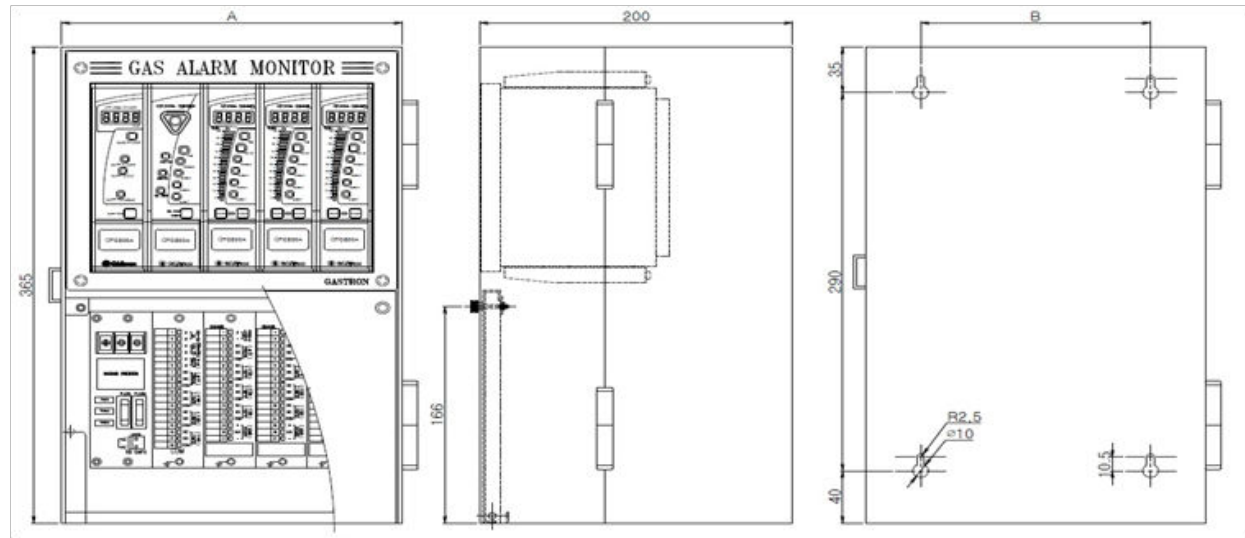

[Figure 13. Outline drawing of Panel Mount (Power Unit not applied)]

Channel	A(mm)	B(mm)	Channel	A(mm)	B(mm)
3 Channel	218	147	7 Channel	361	291
5 Channel	289	219	9 Channel	433	363

Note1) Basic types include 4 types above, and Wall mount of other different sizes is for separate order specifications.

[Table 9. Dimension per channel of Wall Mount Type(Power Unit not applied)]

10.6. Wall mount type(Power Unit not applied)

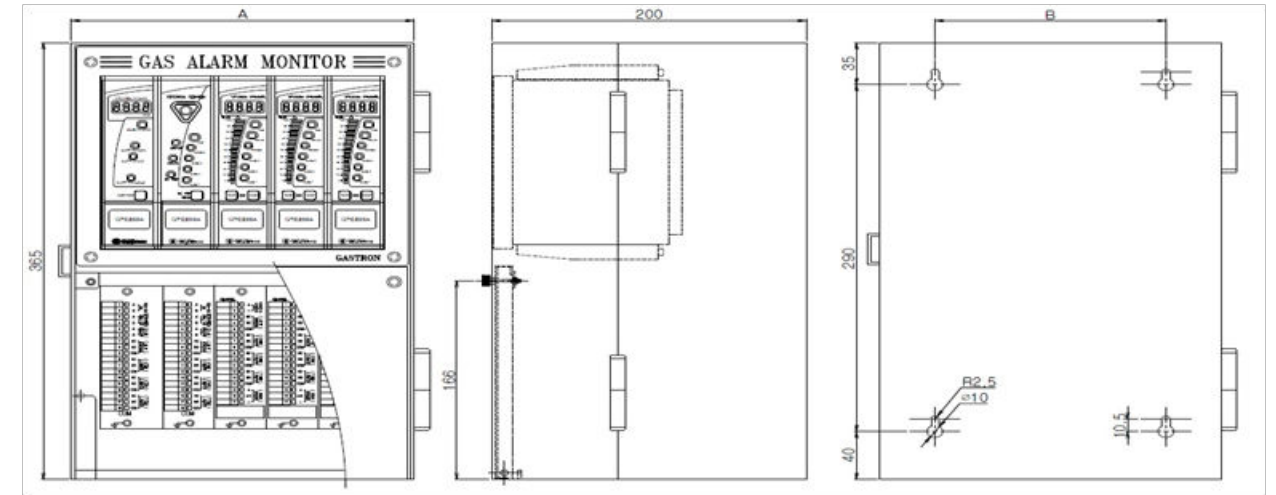

[Figure 14. Outline drawing of Panel Mount(Power Unit applied)]

Channel	A(mm)	B(mm)	Channel	A(mm)	B(mm)
4 Channel	218	147	8 Channel	361	291
6 Channel	289	219	10 Channel	433	363

Note1) Basic types include 4 types above, and Wall mount of other different sizes is for separate order specifications.

[Table 10. Dimension per channel of Wall Mount Type(Power Unit applied)]

Version	Contents	Date
0.0	Manual revised initially	2011. 06. 27
1.0	Font changed, typo corrected	2016. 10. 27