



Headquarters / Engineering research laboratory :
23 Gunpo Advanced Industry 1-ro(Bugok-dong), Gunpo-si, Gyeonggi-do
Tel +82-31-490-0800 Fax +82-31-490-0801

Yeongnam business office / Plant :
55 Gonghangap-gil 85beon-gil, Gangseogu, Busan Metropolitan City
Tel +51-973-8518 Fax +51-973-8519

E-mail : info@gastron.com

www.gastron.com

GTC-520A

Instruction Manual



Read in detail for correct use.

Gas & Flame Detection System

GASTRON

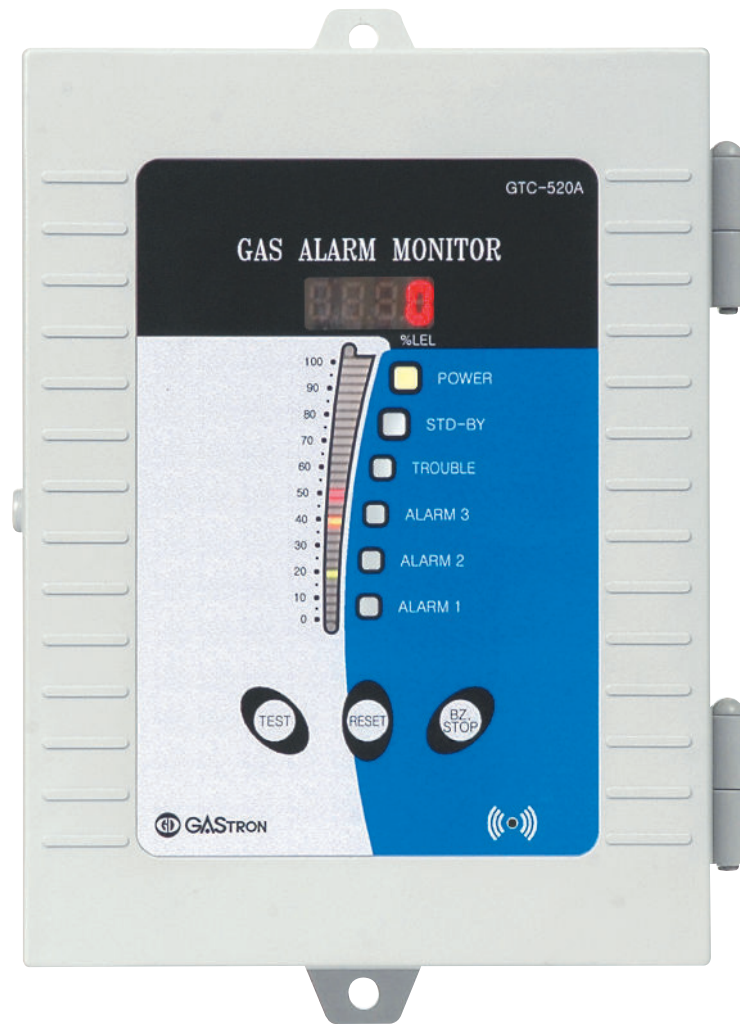

When abnormalities occur after purchasing the product,
please contact the following address.

- Address : 23 Gunpo Advanced Industry 1-ro,
Gunpo-si, Gyeonggi-do
- Tel : 031-490-0800
- Fax : 031-490-0801
- URL : www.gastron.com
- e-mail : info@gastron.com

We sincerely thank you for purchasing the product of Gastron Co. Ltd.

Our Gastron Co.Ltd. is a company specialized in Gas detector and Gas Monitoring System, being recognized by many consumers due to the best quality and use convenience. We always enable you consumers to find desired products nearby and are ceaselessly studying and striving for development of Gas detectors satisfying customers. From now on, solve all anguishes concerning Gas detector with the products of Gastron Co. Ltd, We Gastron Co. will take a responsibility and give you satisfaction.

In the present instruction manual, operation method for Gas detector as well as simple methods for maintenance and repair, etc. are recorded. If you read it in detail and keep it well, for reference when you have questions, then it will give you much help.

- For accurate operation of Gas detector, check up and calibrate for more than once in every 6 months.
(* See No. 13 of KOSHA GUIDE : P-135-2013 / 8.3 paragraph on qualification and calibration)
- For accurate operation of Gas detector, checkup and calibration with calibration gas before measurement is recommended.
- When not calibrated, it may cause malfunction of the equipment due to problems resulting from Sensor aging.
- When the present instrument should be dismantled, those with professional skills for Gas detector should conduct the operation.
- For power supply cable, wire specifications should be determined by referring to the item of "Length of installed cable".
- For the contents on checkup and calibration of Gas detector, please use our company's engineering department , e-mail, or web site.

The present product and the product manual can be changed without advance notice for performance improvement and use convenience of the product.

* KOSHA GUIDE : P-135-2013

Calibration should be executed at periods required by the manufacturer, and should be executed in every quarter unless there are separate calibration periods.

1. Overview	6		
2. Features	6		
3. Specifications	7		
3.1. Basic Specifications	7		
3.2. Mechanical Specifications	7		
3.3. Electrical Specifications (Standard Type)	8		
3.4. Environmental Specifications	8		
4. Name and description of each part	9		
5. Installation	12		
5.1. Configuration of power supply	12		
5.2. Configuration of signal terminal	13		
5.3. Configuration of Relay terminal	14		
5.4. How to connect 3 wire type Gas detector	15		
5.5. How to connect 2 wire type Gas detector	15		
6. How to operate	16		
6.1. Power ON	16		
6.2. Gas Measuring Mode	16		
6.3. Test Mode	17		
6.4. Checkup mode (Stand-by Mode)	17		
6.5. Operation setting	18		
6.5.1. Setting Table	18		
6.5.2. PROGRAM MODE	20		
6.5.3. ALARM Mode	23		
6.5.4. Option mode (Option setting)	27		
6.5.5. Test Mode	30		
6.5.6. 485 setting mode	32		
6.5.7. Maintenance mode	33		
		6.5.8. Factory initialization function (Factory Initial)	35
		6.5.9. Initialization function for calibration data(Calibration Initial)	36
		7. Interface configuration	37
		7.1. MODBUS RS485	37
		7.1.1. Interface setting	37
		7.1.2. MODBUS RS485 Register map	37
		8. Outline drawing and Dimensions	38
		9. Revision record	39

GTC-520A receiver is a receiver unit having adopted high-performance A/D converter and Micro-process with diversified functions embedded. GTC- 520A receiver unit is a stand-alone type receiver connected to one detection unit, protected by the Case using ABS material and displays concentrations using FND digital display and 3 Color bar graphic LED. It has alarm functions of 1st alarm, 2nd alarm, 3rd alarm as well as breakdown alarm function.

2. Features

GTC-520A stand-alone type receiver unit displays with audio signal (Buzzer) and audio signal (Alarm LED) and has functions of holding the maximum measured value upon occurrence of alarm. GTC-520A receiver unit allows remote control for alarm clearing, and has output (SPDT contact) for the alarm so that it can perform the function of interlocking control. GTC-520A receiver unit provides output of 4-20mA.DC for the measured values, and allows digital communication by using RS-485 communication signals(Optional).

3.1. Basic Specifications

ITEMS	SPECIFICATION	
Measuring Value Display	4-Digit FND (32 segment)	
Measuring Range	000.0 ~ 9999 display possible	
Alarm Indicator	Visual display: 3-Alarm, Trouble LED, warning light Audio display: Buzzer signal (85dB)	
Alarm output Signal	3-stage Alarm, Trouble Rley	
Reset signal	RESET switch and remote Reset control	
Input signal	4~20mA DC	
Output signal	Isolated RS-485 Modbus(Optional)	
Approvals Classification	CE	
Basic Interface	Analog 4-20mA current interface	
Option	MODBUS RS485 Board	
Warranty	Body(Transmitter)	2Year
	Sensor	1Year

3.2. Mechanical Specifications

ITEMS	SPECIFICATION	
Dimension	135(W)×180(H)×81(D) mm	
Weight including Sensor	App. 0.6kg	
Mounting type	Wall mount	
Body material	ABS	

3.3. Electrical Specifications (Standard Type)

ITEMS	SPECIFICATION	
Input Voltage(AC Type/Standard)	Absolute min: Nominal: Absolute max:	AC 90V AC 220V AC 250V
Input Voltage(DC Type) ※ Customer supplied PSU must meet requirements IEC1010-1 and CE Marking requirements.	Absolute min: Nominal: Absolute max: Ripple maximum allowed:	18V 24V 31V 1V pk-pk
Wattage(DC Type)	Max. wattage: Max. current:	4.32W @+24 VDC 180mA @+24 VDC
Analog output Current	0-20mA(500 ohms max load) All readings ± 0.2mA Measured-value signal: 4mA(Zero) to 20mA(Full Scale)	
	Fault: 0-100% LEL: 100-109%LEL: Over 110% LEL: Maintenance:	0mA 4mA - 20mA 21.6mA 20mA - 21.4mA 3mA
Analog output current ripple & noise max	±20uA	
Relay contact	Alarm1, Alarm2, Alarm3, Fault Relay AC250V 5A Relay contact(SPDT)	
Wiring requirement	Power	CVVS or CVVSB with shield
	Analog	CVVS or CVVSB with shield
Cable Connection Length	RS485	STP(Shielded Twisted Pair)
	Analog	2500m
EMC Protection:	RS485	1000m

3.4. Environmental Specifications

ITEMS	SPECIFICATION
Operation Temperature	-20 to 60 °C
Storage Temperature	-20 to 60 °C
Operation Humidity	5 to 99% RH (Non-condensing)
Pressure Range	90 to 110KPa

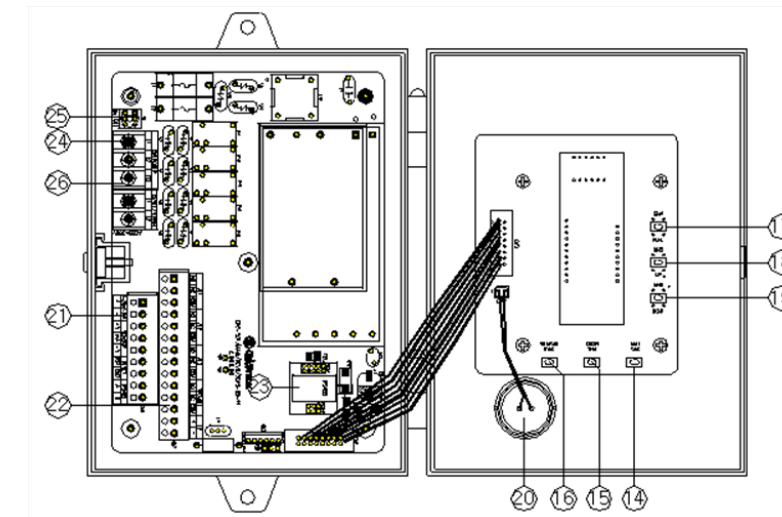
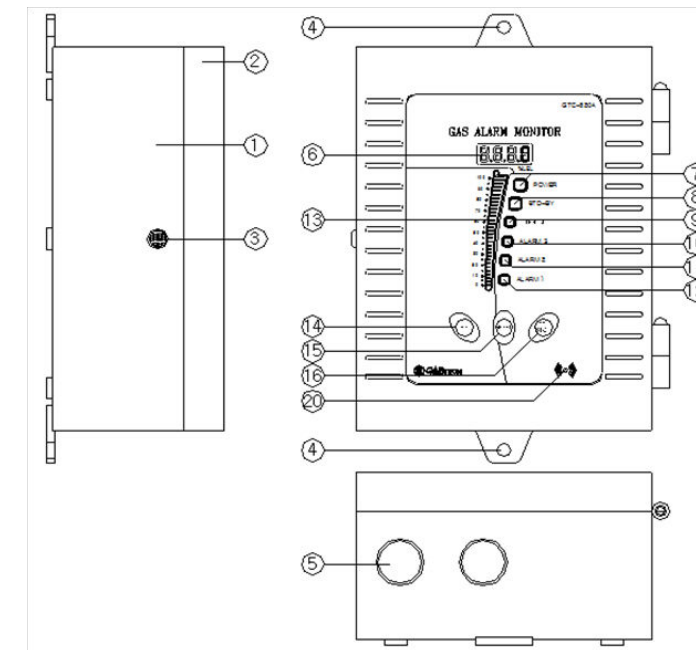

[Figure 1. GTC-520 components]

4. Name and description of each part

No	ITEMS	SPECIFICATION
1	Case body	Made of ABS material to mount Display and protect the circuit from surrounding environment, outside impacts.
2	Case cover	Made of ABS material to mount Main PCB and protect the circuit from surrounding environment, outside impacts.
3	Cover 고정 button	Device to mount cover onto Case body. Cover is opened by pushing the button and pulling the cover forward.
4	Mount hole	Hole to mount Control unit onto outer wall or other Mount plate (2-Ø6)
5	Conduit connection	2 EA of Ø22 holes are configured on upper and lower sides, respectively. Connect power cable, signal Cable, etc. by using cable lead-in port according to field conditions
6	Concentration display (FND Digital display)	Consecutively display measured values of the detector connected to each Channel. Display user-designated value in blinking state upon performing Test function.
7	Power supply LED	Power LED is lighted when power is inputted.
8	Checkup LED	STD-BY LED blinks in the mode for detector checkup
9	Breakdown LED	Trouble LED is lighted upon occurrence of trouble in receiver unit and detection unit. Ex) * Upon occurrence of defective wire connection to detector and of abnormality
10	Alarm3 LED	Alarm 3 LED is lighted upon occurrence of 3rd alarm. Alarm 3 LED is lighted when 3rd alarm is reached upon execution of test function.
11	Alarm2 LED	Alarm 2 LED is lighted upon occurrence of 2nd alarm. Alarm 2 LED is lighted when 2nd alarm is reached upon execution of test function.
12	Alarm1 LED	Alarm 1 LED is lighted upon occurrence of 1st alarm. Alarm 1 LED is lighted when 1st alarm is reached upon execution of test function.
13	3-color bar graph LED	3 Color bar graphic LED consecutively displays measured values and alarm setting values together with FND display. Bar graphic LED is lighted in green when the measured value is less than 1st Alarm, in orange when it is more than 1st Alarm but less than 2nd Alarm, and in red when it is more than 2nd Alarm. When the measured value is more than the alarm setting value, Bar graphic is held at the maximum value, and Bar graphic is displayed in blinking state for the alarm.
14	Test S/W	When test Switch is pushed, the mode performing self diagnosis function is entered into. It is a S/W where the measured value FND blinks and Alarm operation state can be checked by adjusting the measured value using the test Switch. Self diagnosis is cleared by pushing buzzer stop switch and return switch.
15	Return S/W	It performs functions such as clearing of Alarm, clearing of Self test, clearing of Program setting, etc.
16	Buzzer stop S/W	Used for buzzer stop upon occurrence of Alarm.
17	Function S/W	FUNC Switch is a key that converts and select functions such as setting of alarm value, alarm method, Dead band of alarm, delay operation, etc. of alarm to input data values.
18	UP S/W	Used upon increasing the setting values or selecting the next setting values after selection of each mode using the function switch. If UP switch is pushed for a given time in the mode requiring frequent changes of setting values, the setting values are changed fast.

4. Name and description of each part

No	ITEMS	SPECIFICATION
19	DOWN S/W	Used upon decreasing the setting values or selecting the next setting values after selection of each mode using the function switch. If DOWN switch is pushed for a given time in the mode requiring frequent changes of setting values, the setting values are changed fast.
20	Buzzer	Operates with continuous sound when test function is performed upon occurrence of alarm and breakdown alarm.
21	Signal I/O terminal (CN6)	Used for supply of power to gas leakage detector, outputting of 4~20mA current, connection of cables for S-485 MODUS communication, etc.
22	Signal output terminal (CN7)	Used for outputting of Relay Dry Contact Signals such as alarm, breakdown, etc. outputting of DC warning light Signal s, connection of cable, etc.
23	RS-485 module(Optional)	RS-485 communication Module can transmit and receive current concentrations and setting values, etc. by being connected to PC and other outside communication equipment as an Isolation type.
24	Power supply input Terminal (CN9)	Terminal to connect power supply cable for operation of the present control unit.
25	Power supply ON/OFF switch	Switch used for turning ON, OFF of power supply for Control unit . When wire connection operation for cable, etc. is performed, make sure to operate after turning OFF the power supply.
26	Power supply Terminal for outside warning light (CN10)	Assistance power supply Terminal to install outside warning light when the present Control unit is operating.

[Table 1. Description on configuration of GTC-520A]

- Installation in the field or opening or operation of the cover for the installed gas leakage detector and receiving panel should never be allowed to be performed those other than approved users or the person of the headquarters in charge of installation and repair. Otherwise, serious damages can be inflicted to life and property such as fire or explosion accidents. Also make sure to shut off the power supply and conduct operation after checking whether explosive gas remains or flammable substances exist in the surroundings.

5.1. Configuration of power supply

- When the product Cover is separated, the terminal box connecting power supply within PCB and various signals appear.
- Connect AC power supply (85~260V 50/60Hz) to CN9 as shown in the following figure.

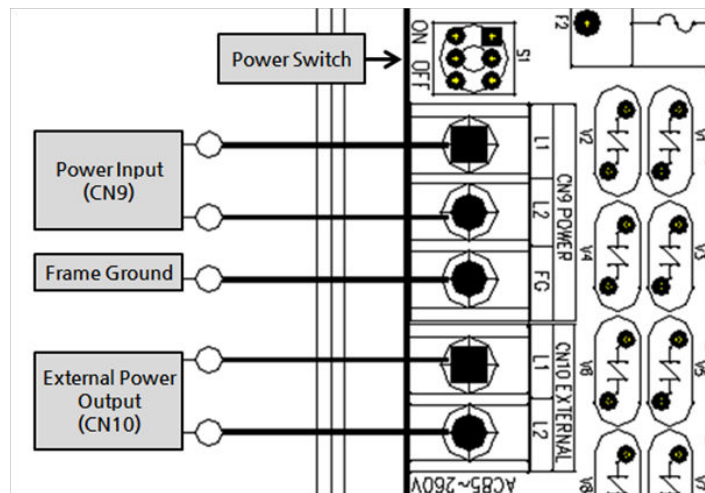

[Figure 2. Configuration of GTC-520A power supply]

- When DC24V is to be used, a separate request should be made upon product ordering. When released as DC24V Type per user request, connect (+) of DC24V (+) to L1 of CN9, and (-) to L2 for use.

5.2. Configuration of signal terminal

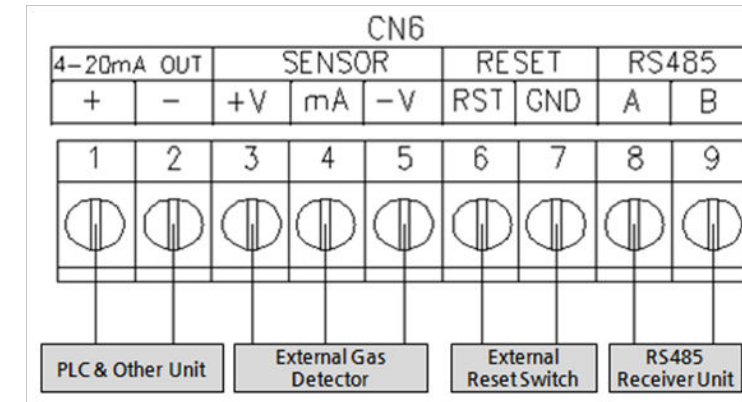

- Connect 4-20mA output and External Reset, RS485, outside gas detector by using CN6 terminal. Terminal configuration is as shown in the following table.
- Use the RS-485 dedicated cable for RS-485 Cable, and use Shield cable of CVS or more than CVVSB 0.75sq for connecting cable between 4~20mA Output and Detector!

FUNCTION OUTSIDE	TERMINAL NAME	DESCRIPTION		
4-20mA Output	VISO	Outside power supply input terminal for 4-20mA Sink Driver		
	mA	Output terminal for 4-20mA Source Driver		
SENSOR	1	Flammability sensor	Toxicity sensor	O2 sensor (galvanic type)
	2	Red Cable	Blue Cable	N.C
RESET	+	arm reset function is performed when outside reset switch + terminal and + terminal are short - circuited with - terminal.		
	-	- terminal of outside reset switch		
RS485	A	RS485 A terminal (TRXD + or P)		
	B	RS485 B terminal (TRXD + or N)		

[Table 2. Description of CN6 terminal]

Note1) When RS485 Option is not available, RS485 function does not operate.

5.3. Configuration of Relay terminal

- By using CN5 terminal, it is configured with 3 ea of SPDT-type Alarm relay, and 1 ea of SPDT -type Trouble relay.
- Alarm Lamp(LP) can be connected with DC outside warning light.
- To use outside DC warning light or outside device, LP terminal outputs DC +24V power supply irrespective of AC, DC power supply mode.

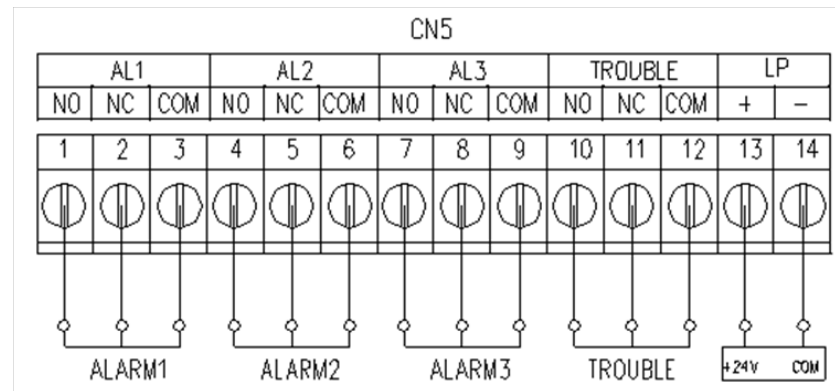

[Figure 4. Configuration of CN5 terminal]

FUNCTION	PIN	TERMINAL NAME	DESCRIPTION
Alarm1	1	NO	Alarm1 Normal Open
	2	NC	Alarm1 Normal Closed
	3	COM	Alarm1 Common
Alarm2	4	NO	Alarm2 Normal Open
	5	NC	Alarm2 Normal Closed
	6	COM	Alarm2 Common
Alarm3	7	NO	Alarm3 Normal Open
	8	NC	Alarm3 Normal Closed
	9	COM	Alarm3 Common
Trouble	10	NO	Trouble Normal Open
	11	NC	Trouble Normal Closed
	12	COM	Trouble Common
LP	13	+	Outside power supply (DC24V) + output
	14	-	Outside power supply (DC24V) - output

[Table 3.Description of CN5 terminal]

5.4. How to connect 3-wire type Gas detector

- When the gas detector is configured with 4-20mA output, connect with the Channel Unit by the method shown on the right side.
- Connecting cable should be configured with shield cable of CVVS or more than CVVSB 0.7sq.
- Our company's detector models of the relevant method include TS-1100Ex, TS-2000Ex, TS-2100 Series, TS-4000 Series, TS-4100P Series, TS-5100 Series, GTD-1000 Series, GTD-2000 Series, GTD-3000 Series, and GIR-3000 Series.

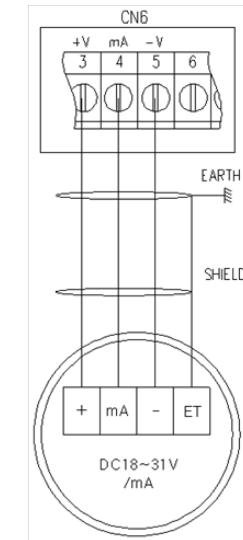

[Figure 5. 3-wire type gas detector]

5.5. How to connect 2-wire type Gas detector

- When output of gas detector is configured with 2-wire(V+,V-), connect with the Channel Unit by the following method.
- Connecting cable should be configured with shield cable of CVVS or more than CVVSB 0.7sq.
- Our company's detector models of the relevant method include TS-1100Tx, TS-2000Tx, TS- 3000 Series, and TS-3100 Series.

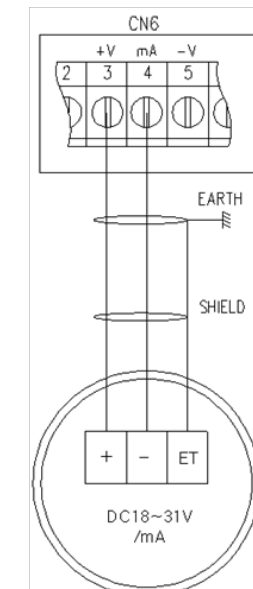

[Figure 6. 2-wire type gas detector]

6.1. Power ON

- Check wire connections for operation power supply, with detection unit, between alarm unit and concentration display unit, etc.
- Turn the power supply switch ON after checking input power supply
- Check lighting of Power LED for alarm unit and concentration display unit.
- Check display of "SELF" in FND of concentration display unit.

	<ul style="list-style-type: none"> - When the power supply for GTC-520A is turned ON, the current Firm Ware Version is displayed. - Figures are displayed after VER is displayed in FND for 0.5 sec. - Current Version is 2.09.
	<ul style="list-style-type: none"> - "SELF" blinks for about 30 sec in FND of concentration display unit, and it immediately becomes measuring state when Warming-up is finished. - If abnormality occurs in the equipment or the detection unit at this time, breakdown alarm occurs.

6.2. Measuring Mode

- If there is no abnormality in SELF TEST after Power On, the following state of gas measurement is automatically entered into.

	<ul style="list-style-type: none"> - Gas concentrations received from the detector are displayed in FND digital display as figures. - Gas concentration is displayed by 3 Color bar graphic LED and FND, in green when the concentration is less than the 1st Alarm, in orange when it is more than the 1st Alarm but less than the 2nd Alarm, and in red when it is more than the 2nd Alarm.
	<ul style="list-style-type: none"> - When the detector is not connected or the current value inputted from the detector is inputted as a current value below the set High scale value by 10%, the text of "Undr" is displayed by blinking at an interval of 1 sec. - Trouble LED is lighted, warning light blinks, and Buzzer sounds. - When "BZSTOP" S/W is pushed, warning light is turned on and Buzzer stops.
	<ul style="list-style-type: none"> - When the current value inputted from the detector is inputted as a current value more than the set High scale value by 10%, the text of "oUER" is displayed by blinking at an interval of 1 sec. - Alarm1,2,3 LED's are lighted, warning light blinks, and Buzzer sounds. - Circular LED on the topmost among 3 Color bar graphic LED is lighted in red.
	<ul style="list-style-type: none"> - When the gas concentration value is recognized as being higher than the Alarm setting value, the relevant Alarm function counts Alarm maintenance time and the Alarm function is operated if it is more than the Alarm maintenance time. - Alarm relay is turned ON when it becomes more than the Alarm maintenance time. - When Alarm Latch Type is in "ON" mode and Alarm function is operated, Alarm state and gas concentration value are maintained at the maximum value, Even when the gas concentration is lowered below the Alarm value, it is not cleared and must be cleared by "RESET" S/W. - When Alarm Latch Type is in "OFF" mode, Alarm function is automatically cleared depending on the gas concentrations.

6.3. Test Mode

- When "Test" S/W is pushed for more than 2 sec in the display state of gas concentration, Test mode is entered into.
- When 30 min passes after the last S/W operation in Test mode, the display state of gas concentration is automatically returned to.

	<ul style="list-style-type: none"> - Upon entering in Test mode, the figure for gas concentration display is displayed by blinking. - This function allows testing in Channel Unit without gas injection in the detector sensor.
Full Range	<ul style="list-style-type: none"> - When the user can set an arbitrary value for gas concentration by pushing "Test" S/W, while Alarm Function is normally operated with the concentration value designated by the user. - When "FUNC" S/W is pushed for more than 2 sec, FND / LED / Bar LED Test function is entered into. - 3 Color bar graph LED alternately displays green, orange and red at an interval of 0.5sec, each function LED blinks at an interval of 0.5 sec. - When "RESET" S/W is pushed, the display state of gas concentration is returned to.

6.4. Checkup mode (Stand-by Mode)

- When "DOWN(Stand-by)" S/W is pushed for more than 2 sec in the display state of gas concentration, the checkup mode is entered into.
- When ETO (Emergency Time Out) was set for ON in Option Setting Mode and so min passes, the display state of gas concentration is automatically returned to.
- Upon ETO OFF, the display state of gas concentration is returned to only when "DOWN(Stand-by)" S/W is pushed for more than 2 sec.

	<ul style="list-style-type: none"> - Function where STD-BY LED blinks, contact output f Trouble/Alarm relay for GTC-520A does not operate with all other functions operating in the checkup mode. - When "DOWN(Stand-by)" S/W is pushed for more than 2 sec, the display state of gas concentration is returned to.
--	---------------------------------------------------------------------------------------------------------------------------------------------------------------------------------------------------------------------------------------------------------------------------------------------------------------------------------------------

6.5. Setting for operation

6.5.1. Setting Table

LEVEL1	LEVEL2	PARAMETER	DEFAULT
PROGRAM MODE Prog	d995 (Gas Funtion)	TY1, Ty2, TY3, TY4	TY1
	d-P5 (Decimal-Point)	100, 1.00, 10.0, 0.100	100
	H-5L (High-Scale)	10~9999	100
	5Rd	-99 ~ 99	0
	PR55 (Pass Word)	0~99	00
	o-5 (Out-Set)	ON, OFF	OFF
	End (End)	-	-
	LACH (LACH)	ON, OFF	ON
	En5 (Energizer)	ON, OFF	OFF
	ALP (Alarm Lamp)	ON, OFF	ON
ALARM MODE ALAR	RL-1 (Alarm-1)	1~Full range	20%/F.R.
	1H (1H)	H, L	H
	1H00 (1H 00)	0~99	00
	RL1E (Alarm 1 Time Delay)	0~60	1
	R1rL (Alarm 1 Relay)	ON, OFF	ON
	R1bL (Alarm 1 Blink)	ON, OFF	OFF
	RL-2 (Alarm-2)	1~Full range	40%/F.R.
	2H (2H)	H, L	H
	2H00 (2H 00)	0~99	00
	RL2E (Alarm 2 Time Delay)	0~60	1
	R2rL (Alarm 2 Relay)	ON, OFF	ON
	R2bL (Alarm 2 Blink)	ON, OFF	OFF
	RL-3 (Alarm-3)	1~Full range	50%/F.R.
	3H (3H)	H, L	H
	3H00 (3H 00)	0~99	00
	RL3E (Alarm 3 Time Delay)	0~60	1
	R3rL (Alarm 3 Relay)	ON, OFF	ON
	R3bL (Alarm 3 Blink)	ON, OFF	OFF
	End (End)	-	-

LEVEL1	LEVEL2	PARAMETER	DEFAULT
Option MODE opt	n-L (Maintenance-Level)	0 ~ Full range	0
	Undr (Under)	ON / OFF	OFF
	En5 (Engineering)	ON / OFF	OFF
	z-5 (Zero-Skip)	0 ~ 20.0%	0
	5-5 (Span-Skip)	0 ~ 20.0%	0
	EtO (Emergency-Timeout)	ON / OFF	OFF
	odt (Outout Delay Time)	0 ~ 60	0
	adu (Outout Delay Value)	0 ~ 20	0
	End (End)	-	-
	Test MODE ALAR	ErLY (Trouble Relay)	ON / OFF
RrLY (Alarm Relay)		ON / OFF	OFF
RoUt (mA out)		ON / OFF	OFF
0 or 100 (0 or 100)		0 or 100 (Blinking)	When ON, starts from 100 When OFF, starts from 0
485 MODE 485	CHno (Channel number)	0~128	1
	PAR (Parity Bit)	0~2	1

[Table 4. Setting Table]

6.5.2. PROGRAM MODE

	<ul style="list-style-type: none"> - When "FUNC" S/W is pushed, Program Mode is entered into. - When "RESET" S/W is pushed, the display state of gas concentration is entered into.
	<ul style="list-style-type: none"> - The first function in setting functions for program data is setting for the position of decimal point. - When "FUNC" S/W is pushed, the setting function for decimal point is entered into. - When "RESET" S/W is pushed, Program Mode is returned to.
	<ul style="list-style-type: none"> - When it is necessary to change the decimal point according to the measurement range. When setting the decimal point position, use "UP" S/W or Each time "DOWN" S/W is pushed, the decimal point position is changed as shown on the left. (Basic value 100) - Ex)100, 10.0, 1.00, 0.100 - Press "FUNC" S/W when the desired decimal position is displayed, to set the decimal position and enter the next item. - Press "RESET" S/W to return to Program Mode.
	<ul style="list-style-type: none"> - Setting function for High scale as a function for setting of the maximum value in gas concentration display. - High Scale value is set for the range specified by domestic regulations upon product shipment. - When "FUNC" S/W is pushed, the setting function for High scale is entered into - When "RESET" S/W is pushed, Program Mode is returned to.

	<ul style="list-style-type: none"> - High scale value is the function where the setting values are changed according to measuring range, and the scale value is increased or decreased whenever "UP" S/W or "DOWN" S/W is pushed (Basic value 100) - If "FUNC" S/W is pushed when the desired High scale value is displayed, the High scale value is set and the next item is entered into. - When "RESET" S/W is pushed, Program Mode is returned to. - The present setting mode is set for the same measuring range as gas detector upon factory shipment. Ex) When Range was set for 100, Upon outputting of 4 mA/DC... 0 Display Upon outputting of 20 mA/DC... 100 Display
	<ul style="list-style-type: none"> - Setting function for SAD value as a function to compensate errors for measured values occurring in detection unit. - When "FUNC" S/W is pushed, the setting function for SAD value is entered into. - When "RESET" S/W is pushed, Program Mode is returned to.
	<ul style="list-style-type: none"> - Function for setting of SAD value. SAD value is increased or decreased whenever "UP" S/W or "DOWN" S/W is pushed, and "-" sign is added above the first figure for display when it is a negative value. (Basic value 0) - If "FUNC" S/W is pushed when the desired SAD value is displayed, the SAD value is set, and the next item is entered into. - When "RESET" S/W is pushed, Program Mode is returned to. (Ex) When the error of output in detector is -2, Display shows 0 by calibration of SAD setting value 2 although the actual Display should indicate -2.
	<ul style="list-style-type: none"> - Setting function for Password. - When "FUNC" S/W is pushed, the setting function for Password is entered into. - When "RESET" S/W is pushed, Program Mode is returned to.
	<ul style="list-style-type: none"> - The value of Password is increased or decreased whenever "UP" S/W or "DOWN" S/W is pushed. (Basic value P00) - If "FUNC" S/W is pushed when the desired Password No. is displayed, the Password No value is set and the next item is entered into. - When "RESET" S/W is pushed, Program Mode is returned to.

0-5	<ul style="list-style-type: none"> - Used when No.1 receiver unit receives mA value outputted from 1 unit of detector and No.2 receiver unit receives mA value outputted from the No.1 receiver unit. - Function used to output the current gas value rather than 3mA when the No.1 receiver unit enters in Password Mode. - When "FUNC" S/W is pushed, the setting function for SAD value is entered into. - When "RESET" S/W is pushed, Program Mode is returned to.
on	<ul style="list-style-type: none"> - Mode to change the Out Set mode. "ON" and "OFF" modes are changed whenever "UP" S/W or "DOWN" S/W is pushed. - When it is "ON", actual Gas value mA is outputted whichever mode of the receiver unit is entered into.
off	<ul style="list-style-type: none"> - When it is "OFF", the mA according to each Mode is outputted in the same way as the existing one. - If "FUNC" S/W is pushed when the desired Out Set Mode is displayed, the Out Set Mode is set and the next item is entered into. - When "RESET" S/W is pushed, Program Mode is returned to.
End	<ul style="list-style-type: none"> - The message informing completion of the setting function is displayed as "End" for 2 sec and the display state of gas concentration is returned to.

6.5.3. ALARM Mode

- If "FUNC" S/W is pushed through moving by "UP" S/W or "DOWN" S/W after setting of Password, it can be entered into.
- When 10 sec passes after the last S/W operation in Alarm setting function, the display state of gas concentration is automatically returned to.

ALAR	<ul style="list-style-type: none"> - Values of Alarm1, Alarm2, Alarm3 can be designated. - When "FUNC" S/W is pushed, Alarm setting function is entered into. - When "RESET" S/W is pushed, the display state of gas concentration is entered into.
LATCH	<ul style="list-style-type: none"> - Function for setting of Alarm Latch Type. - When "FUNC" S/W is pushed, the setting function for Alarm Latch Type is entered into. - When "RESET" S/W is pushed, Alarm Setting Mode is returned to.
on	<ul style="list-style-type: none"> - Mode for change of Alarm reset type. "ON" and "OFF" modes are changed whenever "UP" S/W or "DOWN" S/W is pushed. - If "FUNC" S/W is pushed when the desired Alarm Latch Type is displayed, the Alarm Latch Type is set and the next item is entered into.
off	<ul style="list-style-type: none"> - When "RESET" S/W is pushed, Alarm Setting Mode is returned to. - Alarm Latch Type has 2 modes of "ON" and "OFF", where Alarm is automatically Reset in OFF mode, while Alarm is Reset in ON mode only when the user clears by surely pushing the "RESET" S/W.
ENS	<ul style="list-style-type: none"> - Function to set Energizer Mode for Alarm Relay and Fault Relay. - When "FUNC" S/W is pushed, the setting function for Energizer Mode is entered into. - When "RESET" S/W is pushed, Alarm Setting Mode is returned to.
on	<ul style="list-style-type: none"> - ON/OFF is determined by "UP" S/W or "DOWN" S/W in Energizer Mode. - When it is ON, it is in Normal Open(NO) state. - When it is OFF, it is in Normal Close(NC) state.
off	<ul style="list-style-type: none"> - If "FUNC" S/W is pushed when the desired Energizer Mode is displayed, the Energizer Mode is set and the next item is entered into. - When "RESET" S/W is pushed, Alarm Setting Mode is returned to.

ALP	<ul style="list-style-type: none"> - Mode setting for operation of outside warning light at the desired Alarm. - When "FUNC" S/W is pushed, the setting function for Alarm Lamp is entered into. - When "RESET" S/W is pushed, Alarm Setting Mode is returned to.
on	<ul style="list-style-type: none"> - Set by pushing "UP" S/W and "DOWN" S/W and using "FUNC" S/W in the desired Alarm. - Basic value is designated as "ON".
off	<ul style="list-style-type: none"> - If Alarm sounds when Alarm Lamp is turned ON, the warning light is in lighted state, while the warning light is in blinking state when the lamp is turned OFF. - If "FUNC" S/W is pushed when the desired ALP value is displayed, the ALP value is set and the next item is entered into. - When "RESET" S/W is pushed, Alarm Setting Mode is returned to.
AL-1	<ul style="list-style-type: none"> - The message for setting function of Alarm1 value as a function for setting Alarm 1 value is displayed as "AL-1". - When "FUNC" value is entered into. - When "RESET" S/W is pushed, Alarm Setting Mode is returned to.
<div style="border: 1px solid black; padding: 5px; text-align: center;"> 1 </div> <div style="text-align: center; margin-top: 5px;"> ▼▲ Full Range </div>	<ul style="list-style-type: none"> - Function to change the setting value for Alarm 1. The maximum value is possible up to the High Scale value, and Alarm1 value is increased or decreased whenever "UP" S/W or "DOWN" S/W is pushed. - If "FUNC" S/W is pushed when the desired Alarm1 value is displayed, the Alarm1 value is set and the next item is entered into. - When "RESET" S/W is pushed, Alarm Setting Mode is returned to. - (Basic value : Alarm1 = 20(F/S 20%), Alarm2 = 40(F/S 40%), Alarm3 = 50(F/S 50%))
1H	<ul style="list-style-type: none"> - Alarm level is set for the concentration specified in domestic regulations upon product shipment. - Mode for setting the operation direction of Alarm1, and "1H" or "1L" is displayed whenever "UP" S/W or "DOWN" S/W is pushed.
1L	<ul style="list-style-type: none"> - "1H" mode operates when Gas value is larger than or the same as Alarm1 setting value, while "1L" mode operates when Gas value is smaller than or the same as Alarm1 setting value. - If "FUNC" S/W is pushed when the desired mode is displayed, the mode is set and the next item is entered into. - When "RESET" S/W is pushed, Alarm Setting Mode is returned to.

1400	
1499	<ul style="list-style-type: none"> - Mode for setting of Dead band value with operation of Alarm1. The value is increased or decreased whenever "UP" S/W or "DOWN" S/W is pushed. (Basic value 0)
1L00	<ul style="list-style-type: none"> - Function where Alarm1 operates at more than Alarm value plus Dead band value, while Alarm1 is cleared at less than Alarm value minus Dead band value when Alarm1 is in "1H" mode. - Function where Alarm1 operates at less than Alarm value minus Dead band value while Alarm1 is cleared at more than Alarm 1value plus Dead band value when Alarm1 is in "1L" mode.
1L99	<ul style="list-style-type: none"> - If "FUNC" S/W is pushed when the desired Alarm1 dead band value is displayed, the value is set and the next item is entered into. - When "RESET" S/W is pushed, Alarm Setting Mode is returned to.
AL 1t	<ul style="list-style-type: none"> - Function for setting of Alarm1 delay time. - Function to prevent occurrence of instantaneous malfunction of the detector due to the effects of external impact and noise rather than normal operation. - When "FUNC" S/W is pushed, the setting function for Alarm1 delay time is entered into. - When "RESET" S/W is pushed, Alarm Setting Mode is returned to.
0	<ul style="list-style-type: none"> - For change in Alarm1 delay time, the Alarm1 delay time is increased or decreased by the unit of sec "whenever "UP" S/W or "DOWN" S/W is pushed. (Basic value 1)
60	<ul style="list-style-type: none"> - Ex) When alarm setting value: 20%LEL/delay Time: 5sec, alarm occurs when the measured value of more than the alarm setting value based on 20%LEL exists for more than 5sec, while the alarm does not occur when it falls below the alarm setting value within 5 sec. - If "FUNC" S/W is pushed when the desired Alarm1 delay time is displayed, the Alarm1 delay time is set and the next item is entered into. - When "RESET" S/W is pushed, Alarm Setting Mode is returned to.
A 1rL	<ul style="list-style-type: none"> - Function for setting of Alarm1 contact output. - When "FUNC" S/W is pushed, the setting function for Alarm1 contact output is entered into. - When "RESET" S/W is pushed, Alarm Setting Mode is returned to.

on	<ul style="list-style-type: none"> - Mode for change of Alarm1 contact output. "ON" and "OFF" modes are changed whenever "UP" S/W or "DOWN" S/W is pushed. - Alarm1 contact output mode has 2 types of "ON" and "OFF" where Alarm1 contact output is not operate in OFF mode, while it is operated in ON mode.
off	<ul style="list-style-type: none"> - If "FUNC" S/W is pushed when the desired Alarm1 contact output mode is displayed, the Alarm1 contact output mode is set and the next item is entered into. - When "RESET" S/W is pushed, Alarm Setting Mode is returned to.
A 1bL	<ul style="list-style-type: none"> - Setting function for Alarm1 blink output as a function for setting of Alarm1 contact output for ON/OFF function at the interval of 1 sec while Buzzer is operating. - When "FUNC" S/W is pushed, the setting function for Alarm1 blink output is entered into. - When "RESET" S/W is pushed, Alarm Setting Mode is returned to.
on	<ul style="list-style-type: none"> - Mode for change of Alarm1 blink output. "ON" and "OFF" modes are changed whenever "UP" S/W or "DOWN" S/W is pushed. - Alarm1 blink output mode has 2 types of "ON" and "OFF" where Alarm1 blink output is not operate in OFF mode, while Alarm1 blink output is operated in ON mode. (However, it is operated when Alarm1 contact output mode is ON.)
off	<ul style="list-style-type: none"> - If "FUNC" S/W is pushed when the desired Alarm1 blink output mode is displayed, the Alarm1 blink output mode is set and the next item is entered into. - When "RESET" S/W is pushed, Alarm Setting Mode is returned to. - Both the 2nd alarm (Alarm2) and the 3rd alarm (Alarm3) have the same menu structure.
End	<ul style="list-style-type: none"> - The message informing completion of setting function is displayed as "End" for 2sec, and the display state of gas concentration is returned to.

6.5.4. Option setting

- When "FUNC" S/W is pushed following moving by "UP" S/W or "DOWN" S/W after setting for Password, it can be entered into.
- When 10sec passes after the last S/W operation in Optional setting function, the display state of gas concentration is automatically returned to.
- Since Option Mode is mostly FACTORY setting function, it should be operated under support of Gastron Co. Ltd. when inevitable.

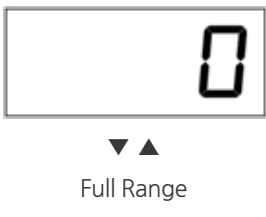





opt	<ul style="list-style-type: none"> - Mode for setting of Optional function. - When "FUNC" S/W is pushed, the optional setting function is entered into. - When "RESET" S/W is pushed, the display state of gas concentration is returned to.
n-L	<ul style="list-style-type: none"> - Mode for display of FND and setting of outputted value in checkup mode. - When "FUNC" S/W is pushed, the setting function for n-L is entered into. - When "RESET" S/W is pushed, Option Setting Mode is returned to.
<div style="text-align: center;">  <p>Full Range</p> </div>	<ul style="list-style-type: none"> - By using "UP" S/W or "DOWN" S/W, setting is possible within the Full Range. - (Basic value : 0 Oxygen : 20.9(Ex, Setting value 0 : 4mA, Full Range : 20mA)) - If "FUNC" S/W is pushed when the desired n-L value is displayed, the selection is set and the next item is entered into. - When "RESET" S/W is pushed, Option Setting Mode is returned to.
Undr	<ul style="list-style-type: none"> - Item for setting use status for marking function of Undr in FND in the case of less than -10% among values less than 0. - When "FUNC" S/W is pushed, the setting function for Under is entered into. - When "RESET" S/W is pushed, Option Setting Mode is returned to.
on	<ul style="list-style-type: none"> - ON/OFF state can be set using "UP" S/W or "DOWN" S/W, and UNDER function can be used in the case of ON. (Initial value OFF)
off	<ul style="list-style-type: none"> - If "FUNC" S/W is pushed when the desired item is displayed, the selection is set and the next item is entered into. - When "RESET" S/W is pushed, Option Setting Mode is returned to.



	<ul style="list-style-type: none"> - For display of the measured value, display unprocessed data from -XXXX to +YYYY. - When "FUNC" S/W is pushed. The setting function for "Under" is entered into. - When "RESET" S/W is pushed, Option Setting Mode is returned to. (This Mode is used only as Test mode, and is not used in actual fields)
	<ul style="list-style-type: none"> - ON/OFF state can be set by using "UP" S/W or "DOWN" S/W, where the function can be used in the case of ON.(Initial value OFF)
	<ul style="list-style-type: none"> - If "FUNC" S/W is pushed when the desired item is displayed, the selection is set and the next item is entered into. - When "RESET" S/W is pushed, Option Setting Mode is returned to.
	<ul style="list-style-type: none"> - Item for setting of Zero Skip. - The value corresponding to the setting range for High scale is subject to zero skip. - When "FUNC" S/W is pushed, the setting function for "S-S" is entered into. - When "RESET" S/W is pushed, Option Setting Mode is returned to.
	<ul style="list-style-type: none"> - Setting is possible within the range of 0 ~ 20(%) by using "UP" S/W or "DOWN" S/W.
	<ul style="list-style-type: none"> - If "FUNC" S/W is pushed when the desired value is displayed, the selection is set and the next item is entered into. - When "RESET" S/W is pushed, Option Setting Mode is returned to.
	<ul style="list-style-type: none"> - Item for setting of Span Skip. - Span skip the value corresponding to the setting range for High scale. - When "FUNC" S/W is pushed, the setting function for "Eto" is entered into. - When "RESET" S/W is pushed, Option Setting Mode is returned to.

	<ul style="list-style-type: none"> - Setting is possible within the range of 0 ~ 20(%) by using "UP" S/W or "DOWN" S/W. - If "FUNC" S/W is pushed when the desired value is displayed, the selection is set and the next item is entered into. - When "RESET" S/W is pushed, Option Setting Mode is returned to.
	<ul style="list-style-type: none"> - When "RESET" S/W is pushed, Option Setting Mode is returned to.
	<ul style="list-style-type: none"> - Item for setting of Emergency Time Out. Status of time setting can be determined upon checkup Mode. - When "FUNC" S/W is pushed, the setting function for Emergency Time Out is entered into. - When "RESET" S/W is pushed, Option Setting Mode is returned to.
	<ul style="list-style-type: none"> - ON/OFF state can be set by using "UP" S/W or "DOWN" S/W. In the case of ON, checkup Mode time is operated for 30 min, while check mode time continues to be operated without restriction in the case of OFF.(Initial value OFF)
	<ul style="list-style-type: none"> - If "FUNC" S/W is pushed when the desired item is displayed, the selection is set and the next item is entered into. - When "RESET" S/W is pushed, Option Setting Mode is returned to.
	<ul style="list-style-type: none"> - The message informing completion of setting function is displayed as "End" for 2 sec, and the display state of gas concentration is returned to.

6.5.5. Test Mode

- When "FUNC" S/W is pushed after moving by "UP" S/W or "DOWN" S/W following setting for Password, it can be entered into.
- When 10 sec passes after the last S/W operation in Test Mode function, the display state of gas concentration is automatically returned to.

	<ul style="list-style-type: none"> - Test mode function allows testing without injection of sensor gas in the detector. The user can set an arbitrary concentration value by pushing "UP" S/W or "DOWN" S/W, and the Alarm function operates normally with the concentration value designated by the user. - When "FUNC" S/W is pushed, the setting function for Test is entered into. - When "RESET" S/W is pushed, the display state of gas concentration is returned to.
	<ul style="list-style-type: none"> - Mode for ON/OFF setting of Trouble Relay Test operation. - When "FUNC" S/W is pushed, the setting function for Trouble Relay is entered into. - When "RESET" S/W is pushed, Test Setting Mode is returned to.
 	<ul style="list-style-type: none"> - ON/OFF state can be set by using "UP" S/W or "DOWN" S/W, and Trouble Relay function can be used in the case of ON. (Initial value OFF) - If "FUNC" S/W is pushed when the desired item is displayed, the selection is set and the next item is entered into. - When "RESET" S/W is pushed, Test Setting Mode is returned to.
	<ul style="list-style-type: none"> - Mode for ON/OFF setting of Alarm Relay Test operation. - When "FUNC" S/W is pushed, the setting function for Alarm Relay is entered into. - When "RESET" S/W is pushed, Test Setting Mode is returned to.
 	<ul style="list-style-type: none"> - ON/OFF state can be set by using "UP" S/W or "DOWN" S/W, and Trouble Relay function can be used in the case of ON. (Initial value OFF) - If "FUNC" S/W is pushed when the desired item is displayed, the selection is set and the next item is entered into. - When "RESET" S/W is pushed, Test Setting Mode is returned to.

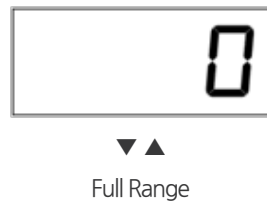
	<ul style="list-style-type: none"> - Test Mode for mA Output Signal . - When "FUNC" S/W is pushed, the setting function for mA Output is entered into. - When "RESET" S/W is pushed, Test Setting Mode is returned to.
 	<ul style="list-style-type: none"> - "ON/OFF state can be set by using "UP" S/W or "DOWN" S/W, and mA OUT function can be used in the case of ON. (Initial value OFF) - If "FUNC" S/W is pushed when the desired item is displayed, the selection is set and the next item is entered into. - When "RESET" S/W is pushed, Test Setting Mode is returned to.
	<ul style="list-style-type: none"> - When Aout is OFF, mA is not outputted although the FND value is changed starting from 0 by using "UP" S/W or "DOWN" S/W. (Basic 3mA) - When Aout is ON, the FND value is outputted from 100, while output current is 20mA and can be changed by using Up S/W or "DOWN" S/W. - (FND: 0~100, mA : 4mA~20mA) - When "FUNC" S/W is pushed, Test Mode Setting Mode is returned to. - When "RESET" S/W is pushed, Test Mode Setting Mode is returned to.

6.5.6. 485 Setting Mode



- When "FUNC" S/W is pushed after moving by "UP" S/W or "DOWN" S/W following setting for Password, it can be entered into.
- When 10 sec passes after the last SW operation in 485 Mode function, the display state of gas concentration is returned to

	<ul style="list-style-type: none"> - Mode for setting of 485 function. - When "FUNC" S/W is pushed, the setting function for 485 is entered into. - When "RESET" S/W is pushed, the display state of gas concentration is returned to.
	<ul style="list-style-type: none"> - Setting function for Channel Number as a function to set for recognition No. of Control Unit. - When "FUNC" S/W is pushed, the setting function for Channel Number is entered into. - When "RESET" S/W is pushed, 485 Mode is returned to.
	<ul style="list-style-type: none"> - Channel Number is the mode to input unique No. of Control Unit so as to allow checking for operation situation of each Control Unit in other equipment such as PC, etc. and Address No. value is increased or decreased whenever "UP" S/W or "DOWN" S/W is pushed. (Basic value 1) - If "FUNC" S/W is pushed when the desired Address No. value s displayed, the selection is set and the next item is entered into.
	<ul style="list-style-type: none"> - Channel No. is set as "1" upon factory shipment, and may be inputted only when use of communication function is desired. When more than 2 units of Control Unit are used, mutually different Nos. must be inputted to avoid mutual overlapping of the Channel No.
	<ul style="list-style-type: none"> - Mode for setting of Parity Bit as the format for 485 communication. - When "FUNC" S/W is pushed, the setting function for Parity Bit is entered into. - When "RESET" S/W is pushed, 485 Mode is returned to.
	<ul style="list-style-type: none"> - Parity Bit is the bit added to the original information to inspect whether errors occurred in the process of information transmission, and the Parity Bit value is increased or decreased whenever "UP" S/W or "DOWN" S/W is pushed. (Basic value 1) - 0 : NONE, 1: EVEN, 2 : ODD
	<ul style="list-style-type: none"> - If "FUNC" S/W is pushed when the desired Parity Bit is displayed, the selection is set and the next item is entered into.

6.5.7. Maintenance Mode

- When "RESET" and "TEST" S/W are pushed for more than 2 sec in the display state of gas concentration, the setting function for Maintenance is entered into.
- The display state of gas concentration is returned to only when "RESET" S/W is surely pushed in Maintenance mode

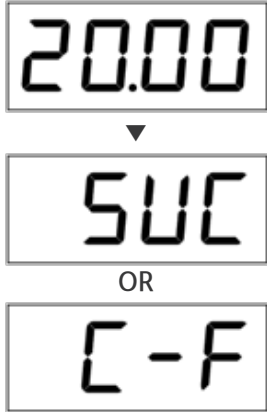
	<ul style="list-style-type: none"> - Mode for selection of the function of outputting current input value and output value as the reference for Channel unit. "In" or "oUt" is displayed whenever "UP" S/W or "DOWN" S/W is pushed. - If "FUNC" S/W is pushed when the desired mode is displayed, the relevant mode is entered into.
	<ul style="list-style-type: none"> - When "In" has been selected, it is the mode for setting of current input value, while it is the mode for setting of current output value when "oUt" has been selected. - When "RESET" S/W is pushed, the display state of gas concentration is returned to.
	<ul style="list-style-type: none"> - Setting mode by inputting of mA current when "In" has been selected - When "FUNC" S/W is pushed, the function of displaying current input value as figures is entered into. - When "RESET" S/W is pushed, the display state of gas concentration is returned to.
	<ul style="list-style-type: none"> - Mode where the value transformed in processor by inputting 4mA current in (mA) terminal is displayed as figures.
	<ul style="list-style-type: none"> - If "FUNC" S/W is pushed when the displayed figure is stable and a current value within the normal range is inputted, SUC(Success) is displayed and the next item is entered into.
	<ul style="list-style-type: none"> - When a current value outside the range is inputted, C-F (Calibration-Fail) is displayed. After checking the current inputted as the current value is displayed again, check by pushing "FUNC" S/W again. - When "RESET" S/W is pushed, the display state of gas concentration is returned to.
	<ul style="list-style-type: none"> - Setting mode by inputting of 20mA current. - When "FUNC" S/W is pushed, the function of displaying the current input value as figures is entered into. - When "RESET" S/W is pushed, the display state of gas concentration is returned to.

 <p>20.00 ▼ SUC OR C-F</p>	<ul style="list-style-type: none"> - Mode for where the value transformed in processor by inputting 20mA current in (mA) terminal is displayed as figures. - If "FUNC" S/W is pushed when the displayed figure is stable and a current value within the normal range is inputted, SUC(Success) is displayed and the next item is entered into. - When a current value outside the range is inputted, C-F (Calibration-Fail) is displayed. After checking the current is inputted as the current value is displayed again, check by pushing "FUNC" S/W again. - When "RESET" S/W is pushed, the display state of gas concentration is returned to.
 <p>3.00 ▼▲ 9.99</p>	<ul style="list-style-type: none"> - Next mode for input current when oUt" has been selected and for setting of 4mA output current. (Basic value 4.00) - If "FUNC" S/W is pushed when the value of ammeter and the value of FND are the same by pushing "UP" S/W or "DOWN" S/W while watching the ammeter after connecting the ammeter to 4~20mA output terminal, the output current value is set and the next item is entered into. - When "RESET" S/W is pushed, the display state of gas concentration is returned to.
 <p>10.00 ▼▲ 30.00</p>	<ul style="list-style-type: none"> - Mode for setting of 20mA output current (Basic value 20.00). - The value is lighted in FND by the unit of 1 sec. - If "FUNC" S/W is pushed when the value of ammeter and the value of FND are the same by pushing "UP" S/W or "DOWN" S/W while watching the ammeter after connecting the ammeter to 4~20mA output terminal, the output current value is set and the next item is entered into. - When "RESET" S/W is pushed, the display state of gas concentration is returned to.

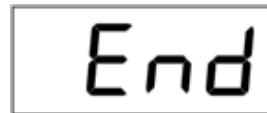
 <p>3.0 ▼▲ 21.0</p>	<ul style="list-style-type: none"> - Testing Mode for output current after calibration is finished. (Basic value 4.0) - It can be checked up to 3.0mA~21.0mA by using "UP" S/W and "DOWN" S/W. - When "FUNC" S/W is pushed after checking is finished, the next item is entered into. - When "RESET" S/W is pushed, the display state of gas concentration is returned to.
 <p>End</p>	<ul style="list-style-type: none"> - The message informing completion of setting function is displayed as "End" for 2 sec, and the display state of gas concentration is returned to.

6.5.8. Factory initialization function(Factory Initial)

- When the power supply is turned ON by pushing "FUNC" S/W + "UP" S/W + "DOWN" S/W , it can be entered into.
- Factory Initial is the mode for initialization of the product data to the existing data upon factory shipment.
- Since Factory Initial is mostly FACTORY setting functions , this function should not be operated. When inevitable, it should be operated with the support of Gastron Co. Ltd.

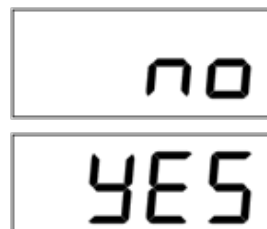
 <p>F-r</p>	<ul style="list-style-type: none"> - Mode for initialization of the currently saved data to the existing data upon factory shipment. - When "RESET" S/W is pushed, the display state of gas concentration is returned to.
 <p>no YES</p>	<ul style="list-style-type: none"> - Enter by pushing "FUNC" S/W. - Yes/no states can be set by using "UP" S/W or "DOWN" S/W. In the case of Yes, Factory Initial function can be used. (Initial value no) - When "RESET" S/W is pushed, the display state of gas concentration is returned to.

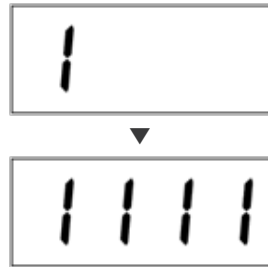

- It is the function using "FUNC" S/W, the cases for consecutive pushing of S/W occur.
- When "FUNC" S/W is operated upon Yes/no to prevent this, "1" -> "11" -> "111" -> "1111" is outputted in FND from the left side by the unit of 0.5s .
- Upon selection of "YES" , initialization is completed, and the display state of gas concentration is returned to.
- Upon selection of "no" , the display state of gas concentration is returned to without initialization.
- Upon selection of "RESET" S/W, the display state of gas concentration is returned to without outputting in FND.

6.5.9. Initialization function for calibration data(Calibration Initial)

- When the power supply is turned ON with "FUNC" S/W + "DOWN" S/W pushed, it can be entered into.
- Calibration Initial is the function for initialization only of calibration value among product's setting values to the basic setting value upon factory shipment.

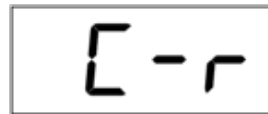

- Mode where only calibration data among the currently saved data to the existing data upon factory shipment.
- When "RESET" S/W is pushed, the display state of gas concentration is returned to.



- Enter by pushing "FUNC" S/W.
- Yes/no states can be set by using "UP" S/W or "DOWN" S/W. In the case of Yes, Calibration Initial function can be used. (Initial value no)
- When "RESET" S/W is pushed, the display state of gas concentration is returned to.

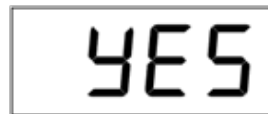

- It is the function using "FUNC" S/W, the cases for consecutive pushing of S/W occur.
- Enter by pushing "FUNC" S/W.
- Yes/no states can be set by using "UP" S/W or "DOWN" S/W. In the case of Yes, Calibration Initial function can be used. (Initial value no)
- When "RESET" S/W is pushed, the display state of gas concentration is returned to.

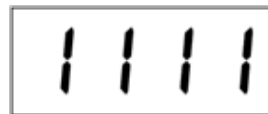

7.1. MODBUS RS485

7.1.1. Interface setting

- Data Format: RTU
- Baud rate: 9600 bps
- Data bits: 8bits
- Stop bit: 1bits
- Parity: Even
- Please see www.modbus.org for other details

7.1.2. MODBUS RS485 Register map

CLASSIFICATION	ADDRESS	BITS	DESCRIPTION
Concentration of measured gas	30001	BIT15~0	Gas measured value(Integer type / Decimal Point not considered)
Setting value for High Scale	30002	BIT15~0	Setting value for High Scale (Integer type / Decimal Point not considered)
Setting value for 1st Alarm	30003	BIT15~0	Setting value for 1st Alarm (Integer type / Decimal Point not considered)
Setting value for 2nd Alarm	30004	BIT15~0	Setting value for 2nd Alarm (Integer type / Decimal Point not considered)
State value for Gas detector	10000	BIT0	Alarm 1 Active state
		BIT1	Alarm 2 Active state
		BIT2	Fault Active state
		BIT3	Maintenance Mode state
		BIT4	Test Mode state
		BIT5	Calibration Mode state
		BIT6	Reserved
Outside Test	3	BIT0~7	Set for Gas detector Test Mode
Outside Reset	2	BIT0~7	Gas detector Test Mode

[Table 5.Configuration of RS485 MODBUS Address]

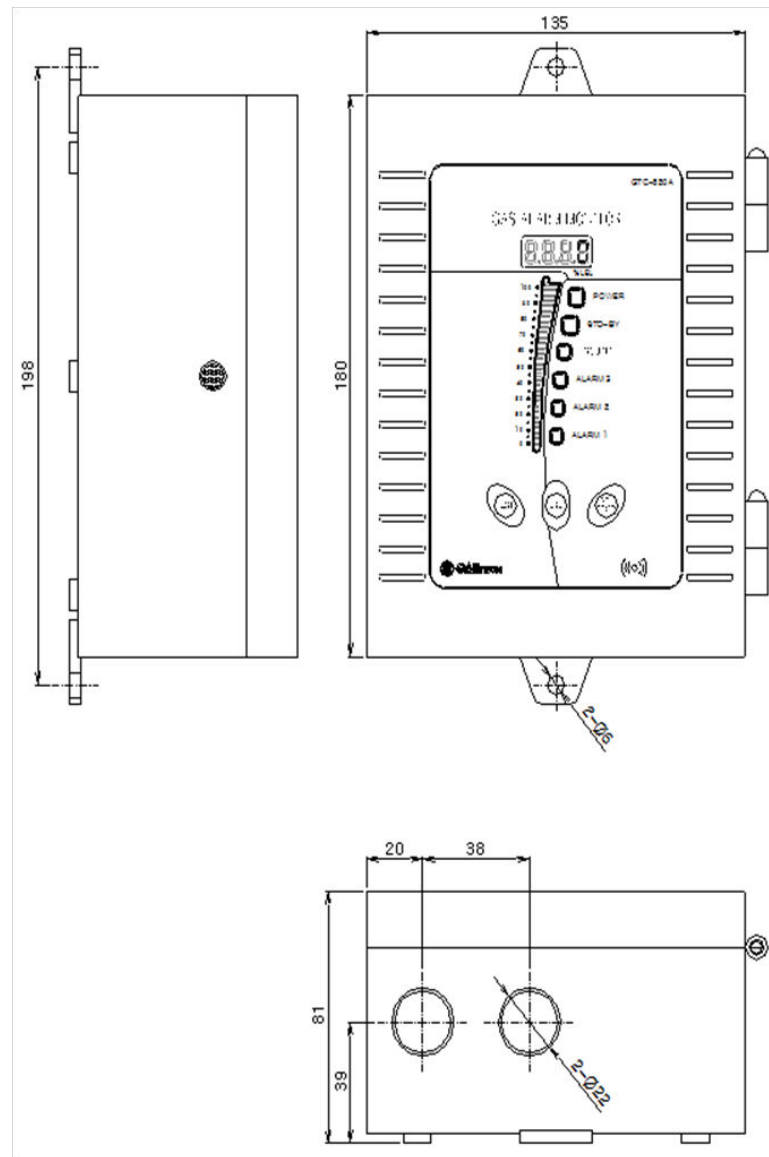

[Figure 7. Outline drawing for GTC-520A]

Version	Contents	Date
0.0	Manual revised initially	2011. 08. 25
1.0	Main PCB Layout changed and functions added	2014. 01. 15
2.0	Program mode functions revised	2015. 04. 27
3.0	Font changed	2016. 09. 23