



Headquarters / Engineering research laboratory :
23 Gunpo Advanced Industry 1-ro(Bugok-dong), Gunpo-si, Gyeonggi-do
Tel +82-31-490-0800 Fax +82-31-490-0801

Yeongnam business office / Plant :
55 Gonghangap-gil 85beon-gil, Gangseogu, Busan Metropolitan City
Tel +51-973-8518 Fax +51-973-8519

E-mail : info@gastron.com

www.gastron.com

GTC-540

Instruction Manual



Read in detail for correct use.

Gas & Flame Detection System

GASTRON



In case of a problem after purchasing the product,
please contact the address below.

- Address : 23 Gunpo Advanced Industry 1-ro,
Gunpo-si, Gyeonggi-do
- Tel : 031-490-0800
- Fax : 031-490-0801
- URL : www.gastron.com
- e-mail : info@gastron.com

We sincerely thank you for purchasing the product of Gastron Co. Ltd.

Our Gastron Co.Ltd. is a company specialized in Gas Detector & Gas Monitoring System and have been recognized by many customers for the best quality and use convenience. We always seek to help our customers to find the product they need and we continuously research to develop gas detectors that satisfies our customers. From now on, you can solve all problems related to gas detectors with the products of Gastron. We Gastron, will be responsible for your satisfaction.

This user manual describes operation and simple maintenance methods etc. for the gas detector. Please read carefully and store it in a safe place. Using it as a reference will help a lot when you have a question during use.

- For an accurate operation of the gas detector, please perform an inspection and a calibration at least once per 6 months.
(* In reference to KOSHA GUIDE: P-135/6-2018 / 7.2 In-house inspection, section 2)
- For an accurate operation of the gas detector, inspection and calibration using a reference gas before measurement is recommended.
- Failure to calibrate may result in malfunction of the equipment due to aging of the sensor.
- Only an individual specialized in gas detector may disassemble the device.
- Wire specification for the power cable must be decided in reference to the "Installation cable length" section.
- Please contact our company's technical support, e-mail, or website for inquiries related to inspection and calibration of the gas detector.

The product and manual are subject to change without a notice for the product's functional improvement and ease of use.

* KOSHA GUIDE : P-135/6-2018

Calibration must be performed at a frequency requested by the manufacturer and shall be performed quarterly when the calibration period is not specified.

| | | | |
|---|----|---|----|
| 1. Overview | 6 | | |
| 2. Characteristics | 6 | | |
| 3. Specifications | 7 | | |
| 3.1. Basic Specifications | 7 | | |
| 3.2. Mechanical Specifications | 7 | | |
| 3.3. Electrical Specifications (Standard Type) | 8 | | |
| 3.4. Environmental Specifications | 8 | | |
| 4. Name and description of each part | 10 | | |
| 5. Installation | 10 | | |
| 5.1. Power Configuration | 10 | | |
| 5.2. Signal Terminal Configuration | 11 | | |
| 5.3. Relay Terminal Configuration | 14 | | |
| 5.4. 3-wire Type Gas detector Connection Method | 15 | | |
| 5.5. 2-wire Type Gas detector Connection Method | 15 | | |
| 6. Operation Method | 16 | | |
| 6.1. Power ON | 16 | | |
| 6.2. Test Mode | 17 | | |
| 6.3. Stand-by Mode | 17 | | |
| 6.4. Operation Setting | 18 | | |
| 6.4.1. Setting Table | 18 | | |
| 6.4.2. PROGRAM MODE | 20 | | |
| 6.4.3. ALARM Mode | 23 | | |
| 6.4.4. Option mode (Option setting) | 27 | | |
| 6.4.5. Test Mode | 29 | | |
| 6.4.6. 485 setting mode | 30 | | |
| 6.4.7. Maintenance mode | 32 | | |
| 6.4.8. Factory Initialization mode | 34 | | |
| | | 6.4.9. Calibration Data Initialization Mode | 35 |
| | | 7. Interface Configuration | 36 |
| | | 7.1. MODBUS RS485 | 36 |
| | | 7.1.1. Interface Setting | 36 |
| | | 7.1.2. MODBUS RS485 Register map | 36 |
| | | 8. Drawings and Dimensions | 37 |
| | | 8.1. Drawings1 | 37 |
| | | 8.2. Drawings2 | 38 |
| | | 9. Revision History | 39 |

Receiver of GTC-540 is a receiver with high-performance A/D converter and micro-processor and has various functions built-in. The receiver is a stand-alone type that connects to a detector and is protected by a case made of ABS material. It displays the concentration using FND digital display and 3-color bar graphic LED. It has primary, secondary, and tertiary alarm functions and fault alarm function.

2. Characteristics

In an event of error, GTC-540 stand-alone receiver displays audible signal (buzzer) and visual signal (Alarm LED) and has a function to hold the maximum measured value. GTC-540 receiver can be controlled remotely to release the alarm and can perform associated control functions since it has an output for an error (SPDT contact). GTC-540 receiver provides 4-20mA. DC output for the measured value and is able to communicate digitally using RS-485 network signal (Option).

3.1. Basic Specifications

| ITEMS | SPECIFICATION | |
|--------------------------|--|----------|
| Measuring Value Display | 1.8" 3-Digit FND & Bar graph(32 segment/3Color) | |
| Measuring Range | Capable to display 00.0 ~ 999 | |
| Alarm Indicator | Visible Indicator: 3-Alarm, Trouble LED, Warning Light | |
| | Audible Indicator: Buzzer Signal (85 dB) | |
| Alarm output Signal | 3-Level Alarm, Trouble Relay | |
| Reset signal | RESET Switch and Remote Reset Control | |
| Input signal | 4~20 mA DC | |
| Output signal | Isolated RS-485 Modbus (Option) | |
| Approvals Classification | CE | |
| Basic Interface | Analog 4-20mA current interface | |
| | MODBUS RS485 Board | |
| Warranty | Transmitter | Warranty |
| | Sensor | |

3.2. Mechanical Specifications

| ITEMS | SPECIFICATION |
|-------------------------|-----------------------------|
| Dimension | 235(W) × 355(H) × 117(D) mm |
| Weight including Sensor | App. 1.4kg |
| Mounting type | Wall mount |
| Body material | ABS |

3.3. Electrical Specifications (Standard Type)

| ITEMS | SPECIFICATION | |
|---|--|---|
| Input Voltage(AC Type/Standard) | Absolute min: Nominal: Absolute max: | AC 90V AC 220V AC 250V |
| Input Voltage(DC Type) ※ Customer supplied PSU must meet requirements IEC1010-1 and CE Marking requirements. | Absolute min: Nominal: Absolute max: Ripple maximum allowed: | 18V 24V 31V 1V pk-pk |
| Wattage(DC Type) | Max. wattage: Max. current: | 4.32W @+24 VDC 180mA @+24 VDC |
| Analog output Current | 0-20mA(500 ohms max load) All readings ± 0.2mA Measured-value signal: 4mA(Zero) to 20mA(Full Scale) | |
| | Fault: 0-100% LEL: 100-109%LEL: Over 110% LEL: Maintenance: | 0mA 4mA - 20mA 21.6mA 20mA - 21.4mA 3mA |
| Analog output current ripple & noise max | ±20uA | |
| Relay contact | Alarm1, Alarm2, Alarm3, Fault Relay AC250V 5A Relay contact(SPDT) | |
| Wiring requirement | Power | CVVS or CVVSB with shield |
| | Analog | CVVS or CVVSB with shield |
| Cable Connection Length | RS485 | STP(Shielded Twisted Pair) |
| | Analog | 2500m |
| EMC Protection: | RS485 | 1000m |

3.4. Environmental Specifications

| ITEMS | SPECIFICATION |
|-----------------------|----------------------------|
| Operation Temperature | -20 to 60 °C |
| Storage Temperature | -20 to 60 °C |
| Operation Humidity | 0~ 99% RH (Non-condensing) |
| Pressure Range | 90 to 110 kPa |

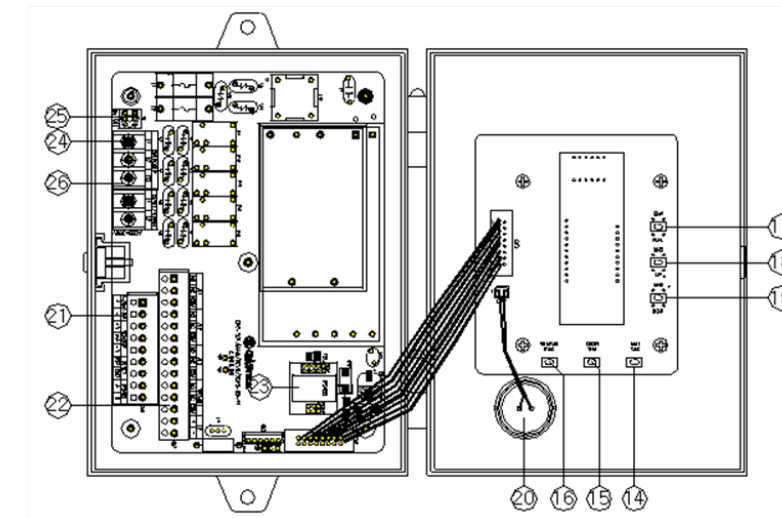
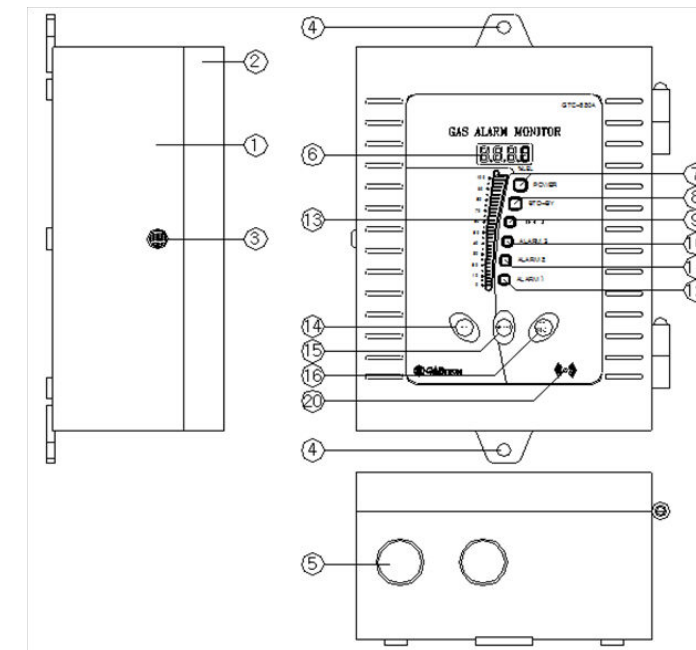

[Figure 1. GTC-540 Components]

4. Name and Description of Each Part

| No | ITEMS | SPECIFICATION |
|----|---|---|
| 1 | Case cover | It is made of ABS Material. It fixes the display and protects the circuit from surrounding environment and external shock. |
| 2 | Case body | It is made of ABS Material. It fixes the Main PCB and protects the circuit from surrounding environment and external shock. |
| 3 | Marking label | Upon an event of error, the warning light turns on. |
| 4 | Mount hole(2-Ø6.5) | It is a hole to fix the control unit to an external wall or other mount plate. |
| 5 | Concentration Display (FND Digital Display) | 6 holes each of Ø16.5 and Ø 20.5 are set at the bottom part. Depending on site condition, power and signal cables, etc. are connected by cable inlet. |
| 6 | O-Ring < NBR > | It works as waterproofing material to prevent rainwater from entering inside. |
| 7 | Power LED | When power is inputted, the power LED lights on. |
| 8 | Stand-by LED | When the detector is in stand-by mode, STD-BY LED flickers. |
| 9 | Trouble LED | Upon an event of trouble in receiver unit and detector part, the trouble LED lights on. Ex.) * Poor wiring with the detector and an event of error |
| 10 | Alarm 3 LED | When the tertiary alarm occurs, Alarm 3 LED lights on. When it reaches Alarm 3 threshold during a test, Alarm 3 LED lights on. |
| 11 | Alarm 2 LED | When the secondary alarm occurs, Alarm 2 LED lights on. When it reaches Alarm 2 threshold during a test, Alarm 2 LED lights on. |
| 12 | Alarm 1 LED | When the primary alarm occurs, Alarm 1 LED lights on. When it reaches Alarm 1 threshold during a test, Alarm 1 LED lights on. |
| 13 | 3-Color Bar Graph LED | 3-Color bar graph LED displays measurement and alarm threshold in a continuous display as FND display. The bar graph LED lights on as green, orange, and red when the measurement is below Alarm 1 threshold, between Alarm 1 and Alarm 2 threshold, and above Alarm 2 threshold, respectively. When the measurement is above the alarm threshold, the bar graph holds the maximum value and flickers to display warning. |
| 14 | "FUNC" S/W | "FUNC" S/W is a key to input data by changing and selecting threshold, type, dead band, delay movement, and etc. settings of the alarm. |
| 15 | "UP" S/W | After selecting each mode using "FUNC" S/W, use to increase the set value or to select the next setting. When a value needs to be changes in a large range, pressing "UP" S/W for a certain time changes the value rapidly. |
| 16 | "DOWN" S/W | After selecting each mode using "FUNC" S/W, use to decrease the set value or to select the previous setting. When a value needs to be changes in a large range, pressing "DOWN" S/W for a certain time changes the value rapidly. |
| 17 | "TEST" S/W | Pressing "TEST" S/W enters a mode that performs self-test. Measurement FND flickers and the value can be adjusted using "UP" S/W and "DOWN" S/W to check the alarm operation status. To release self-test, press "RESET" S/W. |
| 18 | "RESET" S/W | Performs functions to release alarm, self-test, and program setting, etc. |

4. Name and Description of Each Part

| No | ITEMS | SPECIFICATION |
|----|------------------------|---|
| 19 | "BZ-STOP" S/W | Used to stop the buzzer upon an event of alarm |
| 20 | Buzzer | Operates in a continuous tone upon an event of warning or fault during a test. |
| 21 | Terminal Block Cover | To supply power to the equipment, open the terminal block cover and connect power cable. |
| 22 | RS-485 Network | RS-485 network module is isolated type that connects PC and other external network devices to receive and transmit the current concentration and settings, etc. |
| 23 | Module (Option) | Converter that converts 220V-AC to 24V-DC power. |
| 24 | SMPS | S/W used to turn ON and OFF of the control unit power. When performing cable wiring work, power must be turned OFF. |
| 25 | Power ON/OFF S/W | Works as a breaker to protect the equipment by cutting fuse with heat generated from overcurrent. |
| 26 | Fuse | Terminal for power cable connection for operation of the control unit. |
| 27 | Power Input Terminal | Auxiliary power terminal for installation of external warning light during operation of the control unit. |
| 28 | Signal output Terminal | Used for Relay Dry Contract Signal such as warning, failure, etc. and connecting Switch Signal Output Cable, etc. |
| 29 | Signal I/O terminal | Used for connecting cables for power supply of gas leak detector, 4~20 mA current output, and RS-485 MODBUS Network, etc. |
| 30 | Cover Fixing Hook | Device to fix the cover on the case body. To open the cover, push the hook and pull the cover towards the front. |
| 31 | LCD PCB Ass'y | Displays measurement from detector in a continuous manner. During test, it displays user defined value with flickering. |

[Table 1. GTC-540 Configuration Description]

- It is prohibited for an individual, other than an approved user or a technician responsible for installation and repair from the head office, to install a gas detector on site or open the cover of the installed gas leak detector and manipulate it. This may cause serious loss of life and property from fire, explosion, and etc. In addition, please check whether there is any remaining explosive gas or combustible material in the surroundings. Power must be turned off before performing work.

5.1. Power Configuration

- After detaching the equipment cover, terminal block that connects power and various signals within PCB appears.
- Connect AC Power (85~260 V 50/60 Hz) to CN9 as shown in the figure below.

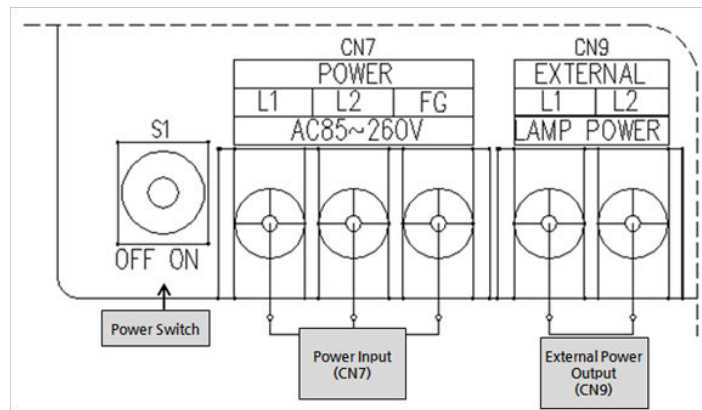

[Figure 2. GTC-540 Power Configuration]

- When it is desired to use DC24V, a separate request must be made when ordering the product. When the product has been delivered as DC24V-Type upon a customer request, (+) and (-) of DC24V shall be connected to L1 and L2 or CN9, respectively.

5.2. Signal Terminal Configuration

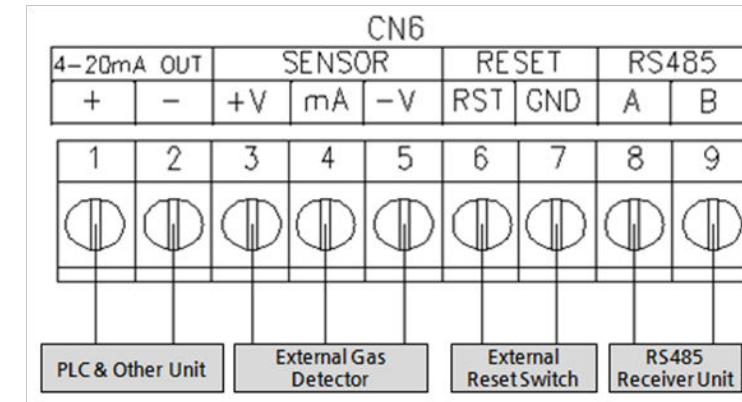

[Figure 3. CN6 Terminal Configuration]

- Using CN6 terminal, connect 4~20 mA output, External Reset, RS485, and external gas detector. Terminal configuration is as shown in the table below.
- RS-485 cable uses a cable designated for RS-485 and cables for 4~20 mA output and detector connection must use a shield cable with CVVS or CVVSB 0.75 sq and higher.

| FUNCTION | TERMINAL NAME | DESCRIPTION | | |
|---------------|---------------|---|--------------|-----------------------------|
| 4-20mA Output | VISO | External power input terminal for 4~20 mA Sink Driver | | |
| | mA | Output terminal for 4~20 mA Source Driver | | |
| SENSOR | 1 | Combustible Sensor | Toxic Sensor | O2 Sensor (Galvanic Method) |
| | 2 | Red Cable | Blue Cable | N.C |
| RESET | + | White Cable | Red Cable | Red Cable |
| | - | External Reset S/W + Terminal. When + and - terminals short, alarm reset function operates. | | |
| RS485 | A | External Reset S/W - Terminal | | |
| | B | RS485 A Terminal (TRXD+ or P) | | |
| | | RS485 B Terminal (TRXD+ or N) | | |

[Table 2. CN6 Terminal Description]

Note 1) When RS485 Option does not exist, RS485 function does not operate.

5.3. Relay Terminal Configuration

- Using CN5 terminal, it consists of 3 SPDT-type Alarm relay and 1 SPDT-type Trouble relay.
- Alarm Lamp (LP) can connect DC external warning light.
- LP terminal output DC +24V power regardless of AC, DC power mode. This is to use an external DC flash light or external devices.

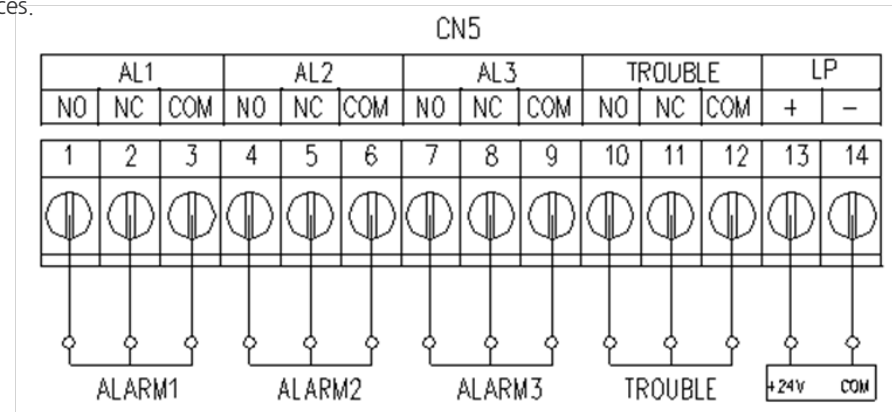

[Figure 4. CN5 Terminal Configuration]

| FUNCTION | PIN | TERMINAL NAME | DESCRIPTION |
|----------|-----|---------------|-----------------------------------|
| Alarm1 | 1 | NO | Alarm1 Normal Open |
| | 2 | NC | Alarm1 Normal Closed |
| | 3 | COM | Alarm1 Common |
| Alarm2 | 4 | NO | Alarm2 Normal Open |
| | 5 | NC | Alarm2 Normal Closed |
| | 6 | COM | Alarm2 Common |
| Alarm3 | 7 | NO | Alarm3 Normal Open |
| | 8 | NC | Alarm3 Normal Closed |
| | 9 | COM | Alarm3 Common |
| Trouble | 10 | NO | Trouble Normal Open |
| | 11 | NC | Trouble Normal Closed |
| | 12 | COM | Trouble Common |
| LP | 13 | + | External Power (DC 24 V) + Output |
| | 14 | - | External Power (DC 24 V) - Output |

[Table 3. CN5 Terminal Description]

5.4. 3-wire Type Gas detector Connection Method

- When the gas detector has 3-wire (V+, mA, V-) for power and 420 mA output components, connect to the Channel Unit as shown in Figure 5.
- Connecting cable must comprise of CVVS or shield cable with CVVSB 0.7 sq or higher.
- Our gas detector models in this type are TS-1100Ex, TS-2000Ex, TS-2100 Series, TS-4000 Series, TS-4100P Series, TS-5100 Series, GTD-1000 Series, GTD-2000 Series, GTD-3000 Series, GIR-3000 Series.

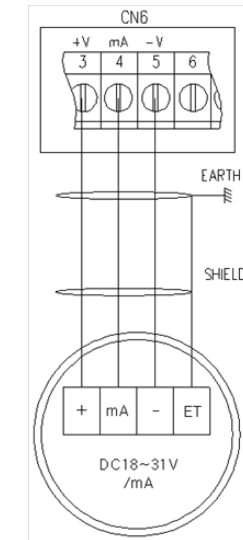

[Figure 5. 3-wire type gas detector]

5.5. 2-wire type Gas detector Connection Method



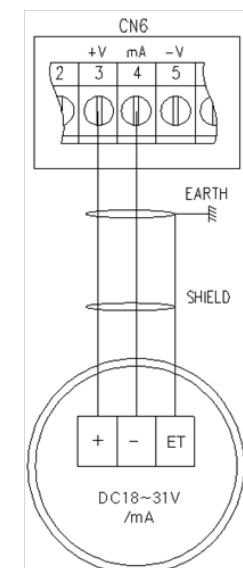

- When the gas detector output has 2-wire (V+, V-), connect to the Channel Unit as shown in Figure 6.
- Connecting cable must comprise of CVVS or shield cable with CVVSB 0.7 sq or higher.
- Our gas detector models in this type are TS-1100Tx, TS-2000Tx, TS-3000 Series, TS-3100 Series.



[Figure 6. 2-wire type gas detector]

6.1. Power ON

- Check wirings for operation power, detection parts, alarm parts, and concentration display.
- Check the power input then turn ON the power S/W.
- Check whether power LED at alarm and concentration display parts light on.
- Check whether "SELF" is displayed on FND concentration display part.

| | |
|---|---|
|  | <ul style="list-style-type: none"> - After GTC-540 power turns ON, the current firm ware version is displayed. - VER is displayed for 0.5 sec on FND then number displays. - The current version is 2.13. |
|  | <ul style="list-style-type: none"> - After warming-up by "SELF" flashing for approx. 30 sec on FND of concentration display, it immediately enters the measurement mode. - Upon an event of fault of the equipment or detector at this time, fault alarm appears. |
|  | <ul style="list-style-type: none"> - Displays gas concentration received by the detector on FND digital display in numbers. - Gas concentration is also displayed by 3-color bar graphic LED. Concentrations below the primary alarm concentration in green, below the secondary alarm concentration in orange, and above the secondary alarm concentration in red. - 3-level alarm thresholds are always displayed by 3-color bar graphic LED. Alarm1 threshold in green, Alarm2 threshold in orange, and alarm3 threshold in red. |
|  | <ul style="list-style-type: none"> - When the detector is not connected or input current from the detector is under 10% below the set high scale value, "Undr" displays and flashes at 1 sec interval - Trouble LED lights on, warning light flashes, and buzzer sounds - When "BZSTOP" S/W is pressed, warning light lights on and buzzer stops |
|  | <ul style="list-style-type: none"> - When the input current from the detector is over 10% above the set high scale value, "ovE" displays and flashes at 1 sec interval. - Alarm 1, 2, 3 LED lights flickers, warning light flickers, and buzzer sounds. - When "BZSTOP" S/W is pressed, warning light lights on and buzzer stops - Top circular LED of the 3-Color bar graphic LED lights on red. - When gas concentration is detected to be above the set value for alarm, alarm function counts the dwell time and if it is above the set dwell time, alarm function operates. - Alarm relay turns on when it is above the alarm dwell time. - When Alarm Latch Type is at "ON" mode and alarm function runs, the alarm status and gas concentration value stays at the maximum value. When gas concentration decreases below the alarm value, alarm does not get released and "RESET" S/W must be ran to release it. - When Alarm Latch Type is OFF, Alarm is released automatically in accordance to gas concentration. |

6.2. Test Mode

- Pressing "TEST" S/W for 2 sec or longer in gas concentration display mode enters Test mode.
- In test mode, when it passes 30 min after the last S/W control, it automatically returns to the gas concentration display mode.

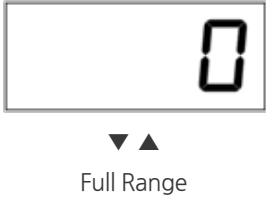
| | |
|---|--|
|  | <ul style="list-style-type: none"> - When it enters Test mode, gas concentration number displays and flickers. - This function enables testing at channel unit without injecting gas to the detector sensor. It can set an arbitrary concentration when the user presses "Test" S/W and alarm function operates normally with a user-defined concentration. - When "FUNC" S/W is pressed 2 sec or longer, it enters FND / LED / Bar LED Test function. - 3-Color bar graph LED displays green, orange, and red at 0.5 s interval and each function LED flickers at 0.5 s interval. - When "RESET" S/W is pressed, it returns to gas concentration display mode. |
|---|--|

6.3. Stand-by Mode

- Pressing "DOWN" S/W for 2 sec or longer in gas concentration display mode enters Stand-by mode.
- PWhen ETO (Emergency Time Out) is set to ON in Option Setting Mode, it automatically returns to gas concentration display mode after 30 min.
- PWhen ETO is OFF, "DOWN(Stand-by)" S/W must be pressed 2 sec or longer to return to gas concentration display mode.

| | |
|---|---|
|  | <ul style="list-style-type: none"> - In stand-by mode, STD-BY LED flickers. Trouble/Alarm relay of GTC-520F contact output does not operate but all other functions run. - When "DOWN(Stand-by)" S/W is pressed 2 sec or longer, it returns to gas concentration display mode |
|---|---|

6.4. Operation Setting

6.4.1. Setting Table

| LEVEL1 | LEVEL2 | LEVEL3 | LEVEL4 (Range available for Selection) | DEFAULT |
|---|--|--|---|----------|
| FUNC→ | FUNC→ | FUNC → | FUNC → NEXT | |
| ↑ P A S S W O R D I N P U T ↓ | ↑ P R O G R A M M O D E ↓ P r 9 | d-9 (Gas Function) | TY1, Ty2, TY3, TY4 | TY1 |
| | | dPS (Decimal-Point) | 100, 10.0, 1.00 | 100 |
| | | HSL (High-Scale) | 10~999 | 100 |
| | | SRd | -99 ~ 99 | 0 |
| | | PR5 (Pass Word) | 0~99 | 00 |
| | | o-5 (Out-Set) | ON, OFF | OFF |
| | | End (End) | - | - |
| | | LRC (LACH) | ON, OFF | ON |
| | | En5 (Energizer) | ON, OFF | OFF |
| | | ALP (Alarm Lamp) | ON, OFF | OFF |
| | | A-1 (Alarm-1) | 1~Full range | 20%/F.R. |
| | | H (1H) | H, L | H |
| | | H00 (1H 00) | 0~99 | 00 |
| | | A1t (Alarm 1 Time Delay) | 0~60 | 0 |
| | | A1r (Alarm 1 Relay) | ON, OFF | ON |
| | | ↑ A L A R M M O D E ↓ A L A | A1b (Alarm 1 Blink) | ON, OFF |
| | A-2 (Alarm-2) | | 1~Full range | 40%/F.R. |
| | H (2H) | | H, L | H |
| | H00 (2H 00) | | 0~99 | 00 |
| | A2t (Alarm 2 Time Delay) | | 0~60 | 0 |
| | A2r (Alarm 2 Relay) | | ON, OFF | ON |
| | A2b (Alarm 2 Blink) | | ON, OFF | OFF |
| | A-3 (Alarm-3) | | 1~Full range | 50%/F.R. |
| | H (3H) | | H, L | H |
| | H00 (3H 00) | | 0~99 | 00 |
| | A3t (Alarm 3 Time Delay) | | 0~60 | 0 |
| | A3r (Alarm 3 Relay) | | ON, OFF | ON |
| | A3b (Alarm 3 Blink) | | ON, OFF | OFF |
| | End (End) | | - | - |

| LEVEL1 | LEVEL2 | LEVEL3 | LEVEL4 (Range available for Selection) | DEFAULT | |
|---|---|---|---|---|-----|
| FUNC→ | FUNC→ | FUNC → | FUNC → NEXT | | |
| ↑ P A S S W O R D I N P U T ↓ | ↑ O P T I O N M O D E ↓ o P t | n-L (Maintenance-Level) | 0 ~ Full range | 0 | |
| | | Und (Under) | ON / OFF | ON | |
| | | En9 (Engineering) | ON / OFF | OFF | |
| | | 2-5 (Zero-Skip) | 0 ~ 20.0% | 0 | |
| | | 5-5 (Span-Skip) | 0 ~ 20.0% | 0 | |
| | | Eto (Emergency-Timeout) | ON / OFF | OFF | |
| | | odt (Output Delay Time) | 0 ~ 60sec | 5 | |
| | | odu (Output Delay Value) | 0 ~ 20% | 7 | |
| | | End (End) | - | - | |
| | | ↑ T E S T M O D E ↓ t-t | ErL (Trouble Relay) | ON / OFF | OFF |
| | | | RrL (Alarm Relay) | ON / OFF | OFF |
| | | | RoU (mA out) | ON / OFF | OFF |
| | 0 or 100 (0 or 100) | | 0 or 100 (Flickering) | When ON, starts from 100 When OFF, starts from | |
| | ↑ 4 8 5 M O D E ↓ 4 8 5 | | CHno (Channel number) | 0~128 | 1 |
| | | | PRr (Parity Bit) | 0~2 | 1 |

[Table 4. Setting Table]

6.4.2. PROGRAM MODE

- After setting a password, move to "UP" S/W or "DOWN" S/W then press "FUNC" S/W to enter the mode.
- In Program setting function, when it passes 10 s after the last S/W control, it automatically returns to gas concentration display mode.

| | |
|--|---|
| | <ul style="list-style-type: none"> - When "FUNC" S/W is pressed, it enters Program Mode. - When "RESET" S/W is pressed, it returns to gas concentration display mode. |
| | <ul style="list-style-type: none"> - It is gas selection function that can be selected by gas type. - When "FUNC" S/W is pressed, it enters Gas Selection Mode. - When "RESET" S/W is pressed, it enters Program Mode. |
| | <ul style="list-style-type: none"> - For each TY selection, High-Scale, d-PS, Alarm (1, 2, 3), Alarm direction, Stand-by mode output, Sensor output characteristic direction, Temperature compensation functions change accordingly. - Decimal point position is set by pressing "UP" S/W or "DOWN" S/W where it changes as shown on the left. (Default TY1) |
| | <ul style="list-style-type: none"> - Value that changes upon TY1 selection (Ex. Tx) - Decimal position setting -> Default 0, Max. gas concentration display possible -> Default 100 - Alarm threshold 1 -> 20 H, 2 -> 40 H, 3 -> 50 H - Stand-by output -> Default 0, Sensor output characteristic direction -> Default dec |
| | <ul style="list-style-type: none"> - Value that changes upon TY2 selection (Membrapor O2) - Decimal position setting -> 1 (25.0) Max. gas concentration display possible -> 250 - Alarm threshold 1 -> 18.0 L, 2 -> 15.0 L, 3 -> 23.0 H - Stand-by output -> Default 20.9, Sensor output characteristic direction -> Default inc - Temperature compensation function -> Default ON |
| | <ul style="list-style-type: none"> - TY3 and TY4 are back up and not used currently. - When a desired TY is displayed, press "FUNC" S/W to set TY and enter the next item. - When "FUNC" S/W is pressed, it enters Program Mode. |
| | <ul style="list-style-type: none"> - It is decimal position setting mode, which is the first function in program data setting mode. - When "FUNC" S/W is pressed, it enters decimal setting mode. - When "RESET" S/W is pressed, it returns to Program Mode. |

| | |
|--|---|
| | <ul style="list-style-type: none"> - Decimal point is used when it is necessary to change decimal point for measured range. |
| | <ul style="list-style-type: none"> - Decimal point position is set by pressing "UP" S/W or "DOWN" S/W where it changes as shown on the left. (Default 100) - Ex) 100, 10.0, 1.00 |
| | <ul style="list-style-type: none"> - When a desired decimal position is displayed, press "FUNC" S/W to set it and enter the next item. - When "FUNC" S/W is pressed, it enters Program Mode. |
| | <ul style="list-style-type: none"> - It is High scale setting mode, which sets the max. gas concentration to be displayed. - High scale value is set in accordance to the domestic regulations as factory setting. - When "FUNC" S/W is pressed, it enters high scale setting mode. - When "RESET" S/W is pressed, it returns to Program Mode. |
| | <ul style="list-style-type: none"> - High scale changes a set value according to measuring range. Scale value increases or decreases upon pressing "UP" S/W or "DOWN" S/W, respectively. (Default 100) |
| | <ul style="list-style-type: none"> - When a desired high scale is displayed, press "FUNC" S/W to set it and enter the next item. - When "RESET" S/W is pressed, it returns to Program Mode. - This setting mode is configured with the same measuring range as gas detector when delivered. Ex.) When range is set to 100. For 4 mA/DC output ... 0 Display For 20 mA/DC output ... 100 Display |
| | <ul style="list-style-type: none"> - SAD setting mode to correct measurement error occurring from the detector. - When "FUNC" S/W is pressed, it enters SAD setting mode. - When "RESET" S/W is pressed, it returns to Program Mode. |

| | |
|---|---|
|  | <ul style="list-style-type: none"> - Function to set SAD value. SAD value increase or decreases when "UP" S/W or "DOWN" S/W is pressed, respectively. For negative value, "-" sign displays above the first digit. (Default 0) - When a desired SAD is displayed, press "FUNC" S/W to set it and enter the next item. - When "FUNC" S/W is pressed, it enters Program Mode. - (Ex.) When output error at detector is -2, the actual display should be -2, but SAD set value of 2 is corrected and 0 is displayed. |
|  | <ul style="list-style-type: none"> - Password setting function. - When "FUNC" S/W is pressed, it enters Password setting mode. - When "RESET" S/W is pressed, it returns to Program Mode. |
|  | <ul style="list-style-type: none"> - Password value increases or decreases when "UP" S/W or "DOWN" S/W is pressed, respectively. (Default P00) - When a desired password no. is displayed, press "FUNC" S/W to set it and enter the next item. - When "RESET" S/W is pressed, it returns to Program Mode. |
|  | <ul style="list-style-type: none"> - Used when receiver 1 receives the mA output from 1 detector and receiver 2 receives the mA output sent from receiver 1. - It is a function to output the current gas value instead of 3 mA when receiver 1 enters password mode. - When "FUNC" S/W is pressed, it enters SAD setting mode. - When "RESET" S/W is pressed, it returns to Program Mode. |
|  | <ul style="list-style-type: none"> - It is a mode to change Out Set Mode and "ON" and "OFF" mode changes when "UP" or "DOWN" S/W are pressed. - When "ON", the actual gas mA value is displayed in any mode entered. - When "OFF", mA corresponding to each mode is outputted as the same as existing setting. - When a desired out set mode is displayed, press "FUNC" S/W to set it and enter the next item. - When "RETURN" S/W is pressed, it returns to Program Mode. |



- A message indicating completion of setting is displayed as "End" for 2 sec then it returns to gas concentration display status.

6.4.3. ALARM Mode

- After setting a password, move to "UP" S/W or "DOWN" S/W then press "FUNC" S/W to enter the mode.
- In Alarm setting function, when it passes 10 sec after the last S/W control, it automatically returns to gas concentration display mode.



- It can designate threshold for Alarm1, Alarm2, and Alarm3.
- When "FUNC" S/W is pressed, it enters Alarm setting mode.
- When "RESET" S/W is pressed, it returns to gas concentration display mode.



- It is a mode that sets Alarm Latch Type.
- When "FUNC" S/W is pressed, it enters Alarm Latch Type setting mode.
- When "RESET" S/W is pressed, it returns to Alarm Setting Mode.





- It is a mode to change Alarm Latch type and "ON" and "OFF" mode changes when "UP" or "DOWN" S/W are pressed.
- When a desired alarm latch type is displayed, press "FUNC" S/W to set it and enter the next item.
- When "RESET" S/W is pressed, it returns to Alarm Setting Mode.



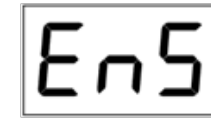



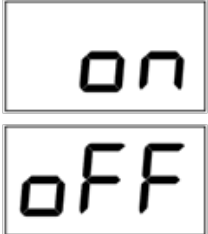

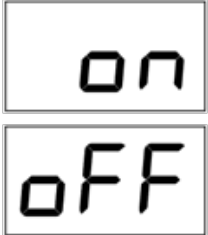
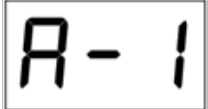
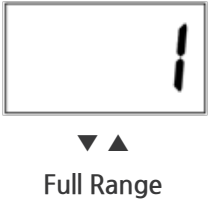
- Alarm Latch Type has two modes: "ON" and "OFF". "OFF" mode automatically resets alarm.
When "ON", the user must press "RESET" S/W to release and reset the alarm.

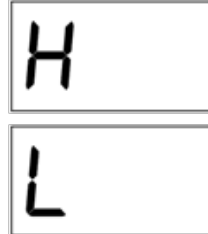
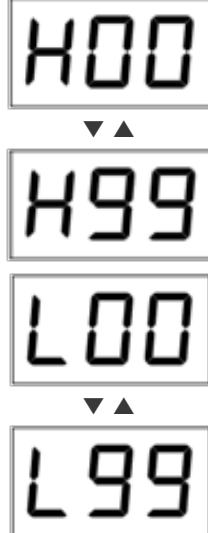

- It is a function that sets Energizer Modes for Alarm Relay and Fault Relay.
- When "FUNC" S/W is pressed, it enters Energizer Mode setting function.
- When "RESET" S/W is pressed, it returns to Alarm Setting Mode.

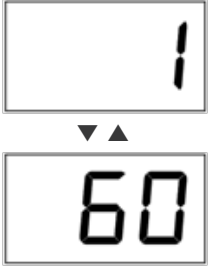
| | |
|---|---|
|  | <ul style="list-style-type: none"> - ON/OFF of Energizer Mode is determined by "UP" S/W or "DOWN" S/W. - When ON, it is in Normal Open (NO) status. - When OFF, it is in Normal Close (NC) status. - When a desired energizer mode is displayed, press "FUNC" S/W to set it and enter the next item. - When "RESET" S/W is pressed, it returns to Alarm Setting Mode. |
|  | <ul style="list-style-type: none"> - Mode that sets external warning lights to operate with a desired alarm. - When "FUNC" S/W is pressed, it enters Alarm Lamp setting mode. - When "RESET" S/W is pressed, it returns to Alarm Setting Mode. |
|  | <ul style="list-style-type: none"> - Select a desired Alarm using "UP" S/W and "DOWN" S/W then set using "FUNC" S/W. - By default, it is set at "OFF". - When Alarm goes off when Alarm Lamp is ON, warning light is on. When it is OFF, warning light is off. - When a desired ALP value is displayed, press "FUNC" S/W to set it and enter the next item. - When "RESET" S/W is pressed, it returns to Alarm Setting Mode. |
|  | <ul style="list-style-type: none"> - Alarm 1 threshold setting function message is displayed as "AL-1" - Press "FUNC" S/W to enter Alarm 1 threshold setting function. - When "RESET" S/W is pressed, it returns to Alarm Setting Mode. |
|  | <ul style="list-style-type: none"> - Function to change Alarm 1 threshold setting. Max. allowable is high scale value. Pressing "UP" S/W or "DOWN" S/W increases or decreases Alarm1 value, respectively. - When a desired alarm 1 threshold is displayed, press "FUNC" S/W to set it and enter the next item. - When "RESET" S/W is pressed, it returns to Alarm Setting Mode. - (Default: Alarm1 = 20(F/S 20%), Alarm2 = 40(F/S 40%), Alarm3 = 50(F/S 50%)) |

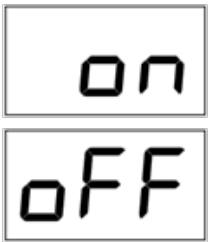
| | |
|---|--|
|  | <ul style="list-style-type: none"> - Alarm level is set to the concentration outlined in domestic regulations as factory setting. - It is a mode to set a direction of Alarm 1 operation. Pressing "UP" S/W or "DOWN" S/W displays "H" or "L", respectively. - "H" mode operates when gas value is equal or greater than Alarm1 setting value. "L" mode operates when gas value is equal or less than Alarm1 set value. - When a desired mode is displayed, press "FUNC" S/W to set it and enter the next item. - When "RESET" S/W is pressed, it returns to Alarm Setting Mode. |
|  | <ul style="list-style-type: none"> - It is a mode to set a dead band for Alarm 1 operation. Pressing "UP" S/W or "DOWN" S/W increases or decrease the value, respectively. (Default 0) - When Alarm 1 is in "H" mode, Alarm 1 operates at values above the sum of Alarm and dead band values and releases below the sum. - When Alarm 1 is in "L" mode, Alarm 1 operation below difference of Alarm and dead band values and releases above the difference - When a desired Alarm1 dead band value is displayed, press "FUNC" S/W to set it and enter the next item. - When "RESET" S/W is pressed, it returns to Alarm Setting Mode. |
|  | <ul style="list-style-type: none"> - It is a mode to set Alarm1 delay time. - It is a function to prevent instantaneous malfunction of detector due to external shock and noise other than from normal operation. - Press "FUNC" S/W to enter Alarm 1 dwell time setting function. - When "RESET" S/W is pressed, it returns to Alarm Setting Mode. |

| | |
|---|---|
|  | <ul style="list-style-type: none"> - To change Alarm 1 delay time, pressing "UP" S/W or "DOWN" S/W increases or decreases the time in unit of seconds (Default 1) - Ex.) Alarm set Value: 20%LEL/delay Time: When it is at 5 sec, Alarm triggers when the measured value is above the set value based on 20%LEL for 5 sec or longer. When it goes down below the set value within 5 sec, alarm is not triggered. - When a desired Alarm 1 delay time is displayed, press "FUNC" S/W to set it and enter the next item. - When "RESET" S/W is pressed, it returns to Alarm Setting Mode. |
|  | <ul style="list-style-type: none"> - It is a mode to set Alarm1 contact output. - Press "FUNC" S/W to enter Alarm 1 contact output setting function. - When "RESET" S/W is pressed, it returns to Alarm Setting Mode. |
|  | <ul style="list-style-type: none"> - It is a mode to change Alarm1 contact output and "ON" and "OFF" mode changes when "UP" S/W or "DOWN" S/W are pressed. - Alarm1 contact output mode has two modes; "ON" and "OFF". In OFF mode, Alarm 1 contact output does not run. In ON mode, it runs. - When a desired Alarm 1 contact output mode is displayed, press "FUNC" S/W to set it and enter the next item. - When "RESET" S/W is pressed, it returns to Alarm Setting Mode. |
|  | <ul style="list-style-type: none"> - Alarm 1 blink output setting function that sets Alarm1 contact output to go ON/OFF at 1 sec interval during buzzer operation. - Press "FUNC" S/W to enter Alarm 1 blink output setting function. - When "RESET" S/W is pressed, it returns to Alarm Setting Mode. |
|  | <ul style="list-style-type: none"> - It is a mode to change Alarm1 blink output and "ON" and "OFF" mode changes when "UP" S/W or "DOWN" S/W are pressed. - Alarm1 blink output mode has two modes; "ON" and "OFF". In OFF mode, Alarm 1 blink output does not run. In ON mode, it runs. (However, it runs when Alarm1 contact output mode is ON.) - When a desired Alarm 1 blink output mode is displayed, press "FUNC" S/W to set it and enter the next item. - When "RESET" S/W is pressed, it returns to Alarm Setting Mode. |



- A message indicating completion of setting is displayed as "End" for 2 sec then it returns to gas concentration display status.

* Alarm 2 and Alarm 3 setting modes are the same as Alarm 1.

6.4.4. Option Mode (Option setting)

- After setting a password, move to "UP" S/W or "DOWN" S/W then press "FUNC" S/W to enter the mode.
- In Option setting mode, when it passes 10 sec after the last S/W control, it automatically returns to gas concentration display mode.
- In option mode, most settings are factory preset, therefore, this function should not be adjusted. When it is unavoidable, the user must seek help from GasTron to adjust.



- It is a mode to set Option function.
- When "FUNC" S/W is pressed, it enters Option setting mode.
- When "RESET" S/W is pressed, it returns to gas concentration display mode.

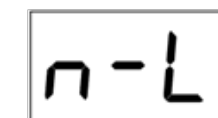

- It is a mode to set FND display and output value when it is in Stand-by Mod
- Press "FUNC" S/W to enter n-L setting function.
- When "RESET" S/W is pressed, it enters Option Setting Mode.



Full Range

- By pressing "UP" S/W and "DOWN" S/W, it can be set in full range.
- (Default: 0 Oxygen : 20.9(Ex., Setting 0 : 4mA, Full Range : 20mA))
- When a desired n-L value is displayed, press "FUNC" S/W to set it and enter the next item.
- When "RESET" S/W is pressed, it enters Option Setting Mode.





- Item to set whether to use a function that displays Und on FND when a negative value is below -10%.
- When "FUNC" S/W is pressed, it enters Under setting mode.
- When "RESET" S/W is pressed, it enters Option Setting Mode.

| | |
|-----|--|
| OFF | <ul style="list-style-type: none"> - By pressing "UP" S/W or "DOWN" S/W, ON/OFF status can be set and when it is ON, UNDER function is available for use. (Default OFF) - When a desired item is displayed, press "FUNC" S/W to set it and enter the next item. - When "RESET" S/W is pressed, it enters Option Setting Mode. |
| Eng | <ul style="list-style-type: none"> - For measurement display, it displays raw data from -XXXX ~ +YYYY. - When "FUNC" S/W is pressed, it enters "Engineer" setting mode. - When "RESET" S/W is pressed, it enters Option Setting Mode. - (This mode is only used as test mode and is not used in the actual field.) |
| ON | <ul style="list-style-type: none"> - By pressing "UP" S/W or "DOWN" S/W, ON/OFF status can be set and when it is ON, the function is available for use. (Default OFF) |
| OFF | <ul style="list-style-type: none"> - When a desired item is displayed, press "FUNC" S/W to set it and enter the next item. - When "RESET" S/W is pressed, it enters Option Setting Mode. |
| Eto | <ul style="list-style-type: none"> - It sets Emergency Time Out. In stand-by mode, the user can decide whether to set the time. - When "FUNC" S/W is pressed, it enters Emergency Time Out setting mode. - When "RESET" S/W is pressed, it enters Option Setting Mode. |
| ON | <ul style="list-style-type: none"> - By pressing "UP" or "DOWN" S/W, ON/OFF status can be set. When it is ON, mode time runs for 30 min and when it is OFF, stand-by mode time continuously runs without limit. (Default OFF) |
| OFF | <ul style="list-style-type: none"> - When a desired item is displayed, press "FUNC" S/W to set it and enter the next item. - When "RESET" S/W is pressed, it enters Option Setting Mode. |
| End | <ul style="list-style-type: none"> - A message indicating completion of setting is displayed as "End" for 2 sec then it returns to gas concentration display status. |

6.4.5. Test Mode

- After setting a password, move to "UP" S/W or "DOWN" S/W then press "FUNC" S/W to enter the mode.
- In test mode, when it passes 10 sec after the last S/W control, it automatically returns to gas concentration display mode.



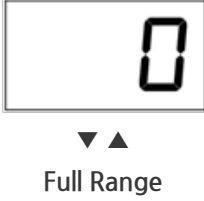

| | |
|-----|--|
| t-t | <ul style="list-style-type: none"> - Test mode enables testing without injecting gas to the detector sensor. The user can set an arbitrary concentration by pressing "UP" or "DOWN" S/W and the alarm function operates normally with a user-defined concentration. - When "FUNC" S/W is pressed, it enters test setting mode. - When "RESET" S/W is pressed, it returns to gas concentration display mode. |
| trL | <ul style="list-style-type: none"> - It is a mode that sets ON/OFF status for Trouble Relay Test Operation. - Press "FUNC" S/W to enter Trouble Relay setting function. - When "RESET" S/W is pressed, it enters Test Setting Mode. |
| ON | <ul style="list-style-type: none"> - By pressing "UP" S/W or "DOWN" S/W, ON/ OFF status can be set and when it is ON, Trouble Relay function is available for use. (Default OFF) |
| OFF | <ul style="list-style-type: none"> - When a desired item is displayed, press "FUNC" S/W to set it and enter the next item. - When "RESET" S/W is pressed, it enters Test Setting Mode. |
| ArL | <ul style="list-style-type: none"> - It is a mode that sets ON/OFF status for Alarm Relay Test Operation. - Press "FUNC" S/W to enter Alarm Relay setting function. - When "RESET" S/W is pressed, it enters Test Setting Mode. |
| ON | <ul style="list-style-type: none"> - By pressing "UP" S/W or "DOWN" S/W, ON/OFF status can be set and when it is ON, Alarm Relay function is available for use. (Default OFF) |
| OFF | <ul style="list-style-type: none"> - When a desired item is displayed, press "FUNC" S/W to set it and enter the next item. - When "RESET" S/W is pressed, it enters Test Setting Mode. |

| | |
|---|--|
|  | <ul style="list-style-type: none"> - It is mA Output Signal Test Mode. - Press "FUNC" S/W to enter mA Output setting function. - When "RESET" S/W is pressed, it enters Test Setting Mode. |
|  | <ul style="list-style-type: none"> - By pressing "UP" S/W or "DOWN" S/W, ON/OFF status can be set and when it is ON, mA out function is available for use. (Default OFF) |
|  | <ul style="list-style-type: none"> - When a desired item is displayed, press "FUNC" S/W to set it and enter the next item. - When "RESET" S/W is pressed, it enters Test Setting Mode. |
|  | <ul style="list-style-type: none"> - When Aout is OFF, it starts from 0. FND value is changed by "UP" S/W or "DOWN" S/W but mA is not outputted. (Default 3mA) - When Aout is ON, FND value outputs from 100 and output current is 20 mA. It can be changed by "UP" S/W or "DOWN" S/W. - (FND: 0~100, mA : 4mA~20mA) - The current test mode is set to output for 1 h after the last S/W operation. After completion of test, "FUNC" or "RESET" S/W must be pressed to return to Test Mode Setting Mode. |

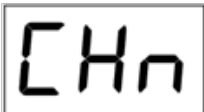
6.4.6. 485 Setting Mode



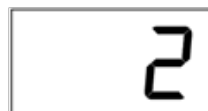

- After setting a password, move to "UP" S/W or "DOWN" S/W then press "FUNC" S/W to enter the mode.
- In 485 mode, when it passes 10 s after the last S/W control, it automatically returns to gas concentration display mode.

| | |
|---|--|
|  | <ul style="list-style-type: none"> - It is a mode that sets 485 function. - When "FUNC" S/W is pressed, it enters Option setting mode. - When "RESET" S/W is pressed, it returns to gas concentration display mode. |
|  | <ul style="list-style-type: none"> - It is channel Number Setting Function that sets Serial Number of Control Unit. - Press "FUNC" S/W to enter Channel number setting function. - When "RESET" S/W is pressed, it returns to gas concentration display mode. |

| | |
|---|---|
|  | <ul style="list-style-type: none"> - Channel number is a mode that enters serial number of control unit to enable recognition of operation status of each control unit at other equipment, such as PC, etc. Pressing "UP" S/W or "DOWN" S/W increase or decreases Address No. Value, respectively. (Default 1) |
|  | <ul style="list-style-type: none"> - When a desired address no. is displayed, press "FUNC" S/W to set it and enter the next item. - Channel No is set at "1" as factory preset and is only entered when network function is to be used. When two or more control unit is used, Channel No. shall not overlap. |
|  | <ul style="list-style-type: none"> - Mode that sets Parity Bit, which is a format of 485 communication. - Press "FUNC" S/W to enter Parity Bit setting function. - When "RESET" S/W is pressed, it returns to gas concentration display mode. |
|  | <ul style="list-style-type: none"> - Parity Bit is an additional bit to the original data to inspect error during transmission of data. Pressing "UP" S/W or "DOWN" S/W increases or decreases Parity Bit value, respectively. (Default 1) |
|  | <ul style="list-style-type: none"> - 0 : NONE, 1 : EVEN, 2 : ODD - When a desired Parity Bit is displayed, press "FUNC" S/W to set it and enter the next item. |

6.4.7. Maintenance Mode

- Pressing both "RESET" and "TEST" S/W for 2 sec or longer in gas concentration display mode enters Maintenance mode.
- "RESET" S/W must be pressed in Maintenance mode to return to gas concentration display mode.

| | |
|---|--|
|  | <ul style="list-style-type: none"> - Mode that selects function to set current input and output values that are reference of Channel unit. Pressing "UP" S/W or "DOWN" S/W displays "In" or "oUt", respectively. - When a desired mode is displayed, press "FUNC" S/W to set it and enter the mode. - When "In" is selected, mode sets current input. When "oUt" is selected, mode sets current output. - When "RESET" S/W is pressed, it returns to gas concentration display mode. |
|  | <ul style="list-style-type: none"> - It is when "In" is selected and a mode that sets by inputting 4 mA current. - Press "FUNC" S/W to enter function that displays current input by number. - When "RESET" S/W is pressed, it returns to gas concentration display mode. |
|  | <ul style="list-style-type: none"> - It is a mode that displays value converted from processor after inputting 4mA current to (mA) terminal. - Press "FUNC" S/W when the displayed number is stable to display SUC (Success) for a current input within normal range and move to the next item. - C-F (Calibration-Fail) displays when a current out of range is inputted. After confirming input current after re-display of current value then press "FUNC" S/W again to confirm. - When "RESET" S/W is pressed, it returns to gas concentration display mode. |
|  | <ul style="list-style-type: none"> - Mode that sets by inputting 20 mA current. - Press "FUNC" S/W to enter function that displays current input by number. - When "RESET" S/W is pressed, it returns to gas concentration display mode. |

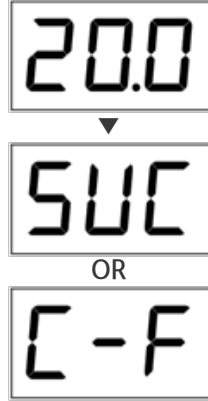
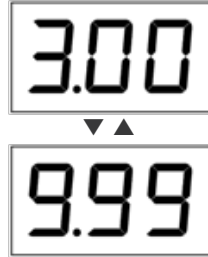
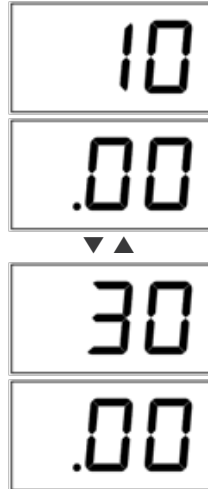
| | |
|--|---|
|  | <ul style="list-style-type: none"> - It is a mode that displays value converted from processor after inputting 20mA current to (mA) terminal. - Press "FUNC" S/W when the displayed number is stable to display SUC (Success) for a current input within normal range and move to the next item. - C-F (Calibration-Fail) displays when a current out of range is inputted. After confirming input current after re-display of current value then press "FUNC" S/W again to confirm. - When "RESET" S/W is pressed, it returns to gas concentration display mode. |
|  | <ul style="list-style-type: none"> - When "oUt" is selected, it is a mode after input current, which sets 4mA output current. (Default 4.00) - Connect ammeter to 4~20 mA output terminal and press "UP" S/W or "DOWN" S/W to match the values on ammeter and FND then press "FUNC" S/W to set output current and move to the next item. - When "RESET" S/W is pressed, it returns to gas concentration display mode |
|  | <ul style="list-style-type: none"> - Mode that sets 20 mA output current. (Default 20.00) - Due to display limit of FND, 10-digit and decimal point digit flashes in 0.5 sec interval. - Connect ammeter to 4~20 mA output terminal and press "UP" S/W or "DOWN" S/W to match the values on ammeter and FND then press "FUNC" S/W to set output current and move to the next item. - When "RESET" S/W is pressed, it returns to gas concentration display mode |

| | |
|--|---|
| | <ul style="list-style-type: none"> - It is a mode that tests output current after calibration. (Default 4.0) - It can confirm a range for 3.0 mA - 21.0 mA with "UP" S/W and "DOWN" S/W. - Pressing "FUNC" S/W after confirmation goes to the next item. - When "RESET" S/W is pressed, it returns to gas concentration display mode. |
| | |
| | <ul style="list-style-type: none"> - A message indicating completion of setting is displayed as "End" for 2 sec then it returns to gas concentration display status. |

6.4.8. Factory Initialization Mode

- By pressing "FUNC" S/W + "UP" S/W + "DOWN" S/W for 2 seconds, it enters the mode.
- Factory initial is a mode that resets the data to the original factory setting.
- In factory initialization mode, most settings are factory preset, therefore, this function should not be adjusted. When it is unavoidable, the user must seek help from GasTron to adjust.

| | |
|--|---|
| | <ul style="list-style-type: none"> - It is a mode that resets the current saved data to the original factory setting. - When "RESET" S/W is pressed, it returns to gas concentration display mode. |
| | <ul style="list-style-type: none"> - Press "FUNC" S/W to enter. - By pressing "UP" S/W or "DOWN" S/W, Yes/no status can be set. When it is "Yes", Factory Initialization function can be used. (Default "no") - When "RESET" S/W is pressed, it returns to gas concentration display mode. |
| | |

| | |
|--|---|
| | <ul style="list-style-type: none"> - It is a function that uses "FUNC" S/W, therefore, there are cases where S/W is pressed repeatedly. - To prevent this, when "FUNC" S/W is used for Yes/no, FND displays "1" -> "11" -> "111" from the left in 0.5 sec interval. - When "YES" is selected, initialization is complete and it will reboot the unit. - When "no" is selected, it returns to gas concentration display mode without initialization. - Selecting "RESET" S/W returns to gas concentration display mode without FND display. |
| | |

6.4.9. Calibration Data Initialization Mode

- By pressing "FUNC" + "UP" S/W and turning ON power, it enters the mode.
- Calibration Initialization only resets calibration value to factory setting.

| | |
|--|--|
| | <ul style="list-style-type: none"> - It is a mode that resets only calibration data from the currently saved data to the original factory setting. - When "RESET" S/W is pressed, it returns to gas concentration display mode. |
| | <ul style="list-style-type: none"> - Press "FUNC" S/W TO enter. - By pressing "UP" S/W or "DOWN" S/W, Yes/no status can be set. When it is "Yes", Calibration Initialization function can be used. (Default "no") - When "RESET" S/W is pressed, it returns to gas concentration display mode.- |
| | |
| | <ul style="list-style-type: none"> - It is a function that uses "FUNC" S/W, therefore, there are cases where S/W is pressed repeatedly. - To prevent this, when "FUNC" S/W is used for Yes/no, FND displays "1" -> "11" -> "111" -> "1111" from the left in 0.5 sec interval. - When "YES" is selected, initialization is complete and it will reboot the unit. - When "no" is selected, it returns to gas concentration display mode without initialization. - Selecting "RESET" S/W returns to gas concentration display mode without FND display. |
| | |

7.1. MODBUS RS485

7.1.1. Interface setting

- Data Format: RTU
- Baud rate: 9600 bps
- Data bits: 8bits
- Stop bit: 1bits
- Parity: Even
- For details, please go to www.modbus.org

7.1.2. MODBUS RS485 Register map

| TYPE | ADDRESS | BITS | DESCRIPTION |
|----------------------------|---------|---------|--|
| Measured Gas Concentration | 30001 | BIT15~0 | Gas Measurement (Integer/Decimal point is not considered) |
| High Scale Setting | 30002 | BIT15~0 | High Scale Setting (Integer/Decimal point is not considered) |
| Alarm 1 Setting | 30003 | BIT15~0 | Alarm 1 Setting (Integer/Decimal point is not considered) |
| Alarm 2 Setting | 30004 | BIT15~0 | Alarm 2 Setting (Integer/Decimal point is not considered) |
| Gas detector status value | 10000 | BIT0 | Alarm 1 Active Status |
| | | BIT1 | Alarm 2 Active Status |
| | | BIT2 | Alarm 3 Active Status |
| | | BIT3 | Fault Active Status |
| | | BIT4 | Test Mode Status |
| | | BIT5 | Maintenance Mode Status |
| | | BIT6 | Reserved |
| | | BIT7 | Toggle Bit (Bit reversal in 2 sec interval) |
| External Test | 3 | BIT0~7 | Gas Detector Test Mode Setting |
| External Reset | 2 | BIT0~7 | Exit Gas Detector Test Mode |

[Table 5. RS485 MODBUS Address Configuration]

8.1. Drawing 1

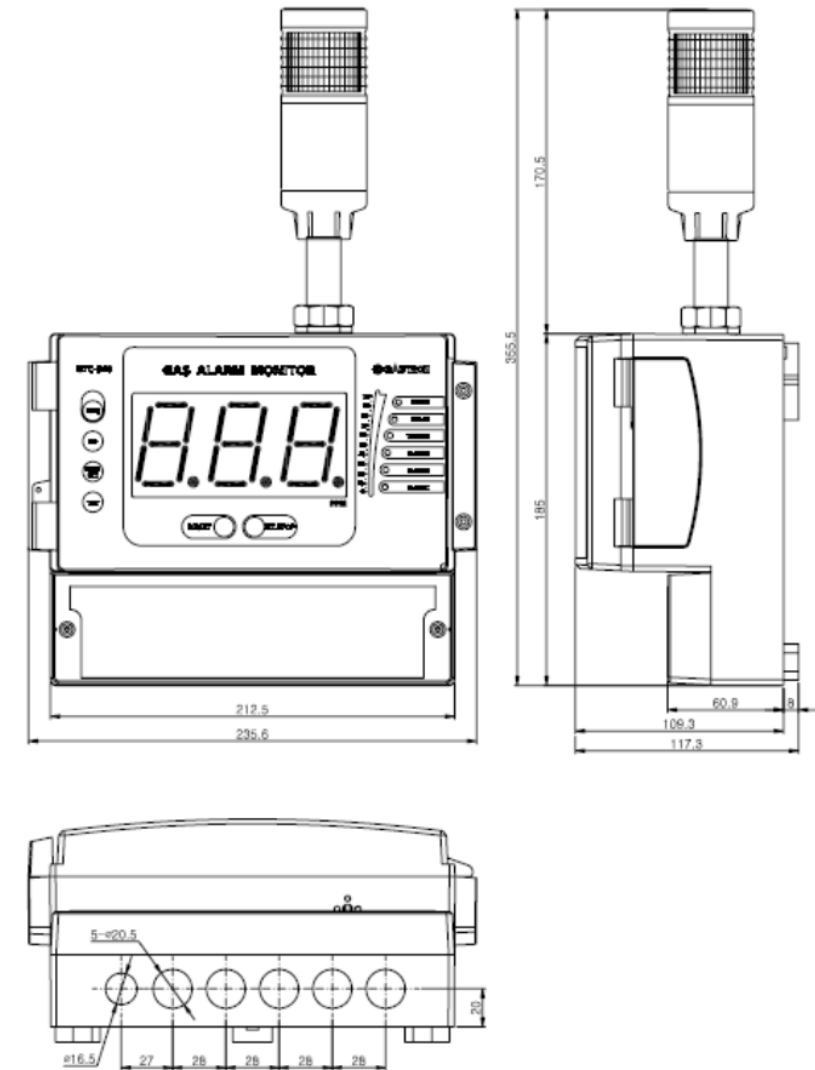

[Figure 7. GTC-540 Drawing 1]

8.2. Drawing 2

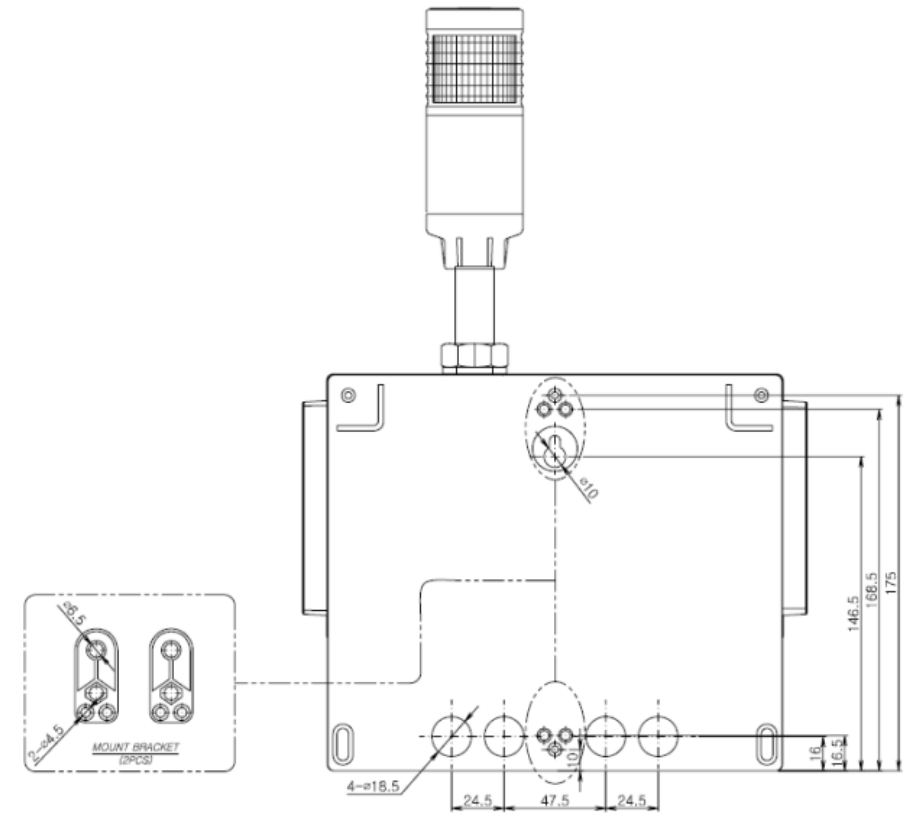

[Figure 8. GTC-540 Drawing 2]

| VERSION | CONTENTS | DATE |
|---------|--|--------------|
| 0.0 | Initial Revision of Manual | 2011. 08. 25 |
| 1.0 | Changed Main PCB Layout and Added function | 2014. 01. 15 |
| 2.0 | Corrected Program Mode Function | 2015. 04. 27 |
| 3.0 | Changed Font | 2016. 09. 23 |