



Headquarters / Engineering research laboratory :
23 Gunpo Advanced Industry 1-ro(Bugok-dong), Gunpo-si, Gyeonggi-do
Tel +82-31-490-0800 Fax +82-31-490-0801

Yeongnam business office / Plant :
55 Gonghangap-gil, 85beon-gil, Gangseogu, Busan Metropolitan City
Tel +51-973-8518 Fax +51-973-8519

E-mail : info@gastron.com

www.gastron.com

GTD-6000

Instruction Manual



Read in detail for correct use.

Gas & Flame Detection System

GASTRON



When abnormalities occur after purchasing the product,
please contact the following address.

- Address : 23 Gunpo Advanced Industry 1-ro,
Gunpo-si, Gyeonggi-do
- Tel : 031-490-0800
- Fax : 031-490-0801
- URL : www.gastron.com
- e-mail : info@gastron.com

We sincerely thank you for purchasing the product of Gastron Co. Ltd.

Our Gastron Co.Ltd. is a company specialized in Gas detector and Gas Monitoring System, being recognized by many consumers due to the best quality and use convenience. We always enable you consumers to find desired products nearby and are ceaselessly studying and striving for development of Gas detectors satisfying customers. From now on, solve all anguishes concerning Gas detector with the products of Gastron Co. Ltd, We Gastron Co. will take a responsibility and give you satisfaction.

In the present instruction manual, operation method for Gas detector as well as simple methods for maintenance and repair, etc. are recorded. If you read it in detail and keep it well, for reference when you have questions, then it will give you much help.

- For accurate operation of Gas detector, check up and calibrate for more than once in every 6 months.
(* See No. 13 of KOSHA GUIDE : P-135-2013 / 8.3 paragraph on qualification and calibration)
- For accurate operation of Gas detector, checkup and calibration with calibration gas before measurement is recommended.
- When not calibrated, it may cause malfunction of the equipment due to problems resulting from Sensor aging.
- When the present instrument should be dismantled, those with professional skills for Gas detector should conduct the operation.
- For power supply cable, wire specifications should be determined by referring to the item of "Length of installed cable".
- For the contents on checkup and calibration of Gas detector, please use our company's engineering department , e-mail, or web site.

The present product and the product manual can be changed without advance notice for performance improvement and use convenience of the product.

* KOSHA GUIDE : P-135/6-2018

Calibration should be executed at the periods required by the manufacturer, and should be executed every quarter unless there are separate calibration periods.

1. Overview	6		
2. Configuration	6		
3. Specification	7		
3.1. Basic Specifications	7		
3.2. Mechanical Specifications	7		
3.3. Electrical Specifications (Standard Type)	8		
3.4. Environmental Specifications	9		
4. Name and Description of Each Part	10		
4.1. Components	10		
5. Installation	13		
5.1. Detachment of Terminal Block Cover	13		
5.2. Power Terminal Configuration	13		
5.3. Signal Terminal Configuration	15		
5.4. Relay Terminal Configuration	16		
5.5. Installation Cable Length	18		
6. Detector Operation Flow	19		
6.1. Initial Operation Status (Power On)	19		
6.2. Measuring Mode	19		
6.3. Gas Test Function Operation	20		
6.4. Set-up Mode Entry Status	20		
6.5. Operation Flow	20		
6.6. Menu Configuration Table	21		
7. System Mode	23		
7.1. PROGRAM MODE	23		
7.2. CALIBRATION MODE	25		
		7.2.1. Zero Calibration	25
		7.2.2. Span Calibration	26
		7.3. ALARM MODE	27
		8. Troubleshooting	30
		8.1. Fault List	30
		8.2. Recovery List	30
		9. Interface Configuration	31
		9.1. MODBUS RS485	31
		9.1.1. Interface setting	31
		9.1.2. MODBUS RS485 Register map	31
		10. Drawings and Dimensions	32
		10.1. Drawing 1	32
		10.2. Drawing 2	33
		11. Precautions before Installation	34
		11.1. Selecting a Place for Installation (Occupation Safety and Health Act Data)	34
		11.2. Selecting a Site for Installation (High-Pressure Gas Safety Control Act Data)	34
		11.3. Precautions during Installation	34
		12. Revision History	35

GTD-6000 gas detector has been developed to detect gas leaked from industrial sites and various toxic gases generated from factories, gas storages, and manufacturing processes that produce or use toxic gases and to prevent accidents in advance. GTD-6000 gas detector is installed in areas with gas leak hazards and continuously monitors gas leak. It displays measurements on built-in FND within the gas detector, output DC 4~20 mA standard signal and RS-485 network signal, and provides relay contact signal in case of gas leak alarm event.

Also, DC 4~20 mA standard output is capable of connecting max. 2,500 m for output signal transmission between gas detector and receiver (when using VVS or CVVSB 1.5sq \uparrow Shield Cable). For RS-485 network signal, it is capable of transmitting up to 1,000 m (when using RS-485 designated shield cable).

2. Configuration

GTD-6000 case is made of ABS for protection.

This product can be installed in areas with combustible gas leak and explosion hazards. 4-Digit FND built-in the gas detector displays gas leak status as installed site. Internal structure consists of display that indicates measurement, main control that measures and controls gas concentration and flow rate, and terminal that sends current output (DC 4 ~ 20 mA) or RS-485 network signal, and alarm signal externally.

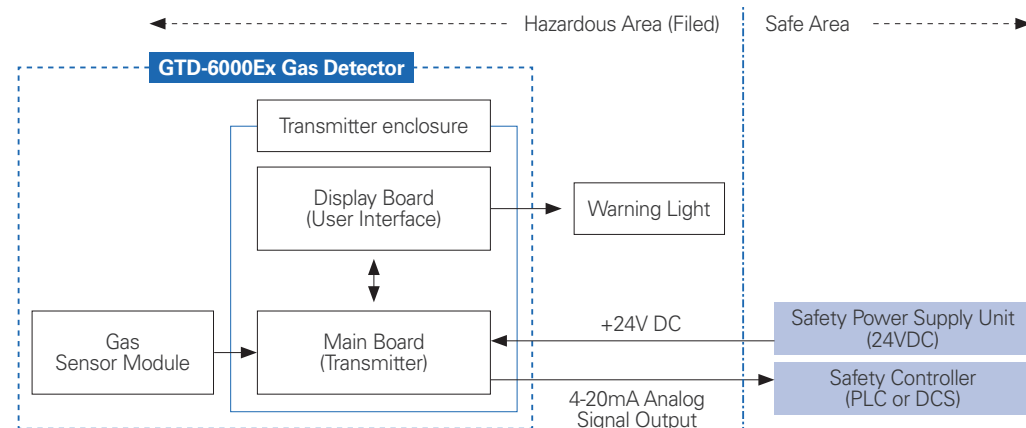

[Figure 1. GTD-6000 Overview]

3.1. Basic Specifications

ITEMS	SPECIFICATION	
Measuring Type	Diffusion	
Measuring Value Display	4-digit 1.8" FND Display	
Measuring Method	Catalytic	
	Electro-Chemical Cell	
Detectible Gas	Combustible Gas	
	Toxic Gas)	
	Oxygen (Note 1)	
Measuring Range	Capable to display 0000 ~ 9999 (Note 1)	
Accuracy	≤ ±3% / Full Range	
Zero Drift	≤ 2% / Full Range	
Response Time	Depends on Sensor Module. Refer to Sensor Specification or Contact in case for Special Gas.	
Alarm Indicator	Visible Indicator: 3-Alarm, Trouble LED, Warning Light Audible Indicator: Buzzer Signal (85 dB)	
Approvals Classification	-	
Basic Interface	Analog 4-20mA current interface	
Option	MODBUS RS485	
Warranty	Transmitter	2Year
	Sensor	1Year

※ Note1. Refer to the measured gas list for measured gases and their ranges. Contact us for special gas.

3.2. Mechanical Specifications

ITEMS	SPECIFICATION	
Dimension)	235.6(W) × 355.5(H) × 109.3(D) mm	
Weight including Sensor	App. 1.75kg	
Mounting type	Wall mount	
Cable inlet	3/4" PF (1/2" or 3/4" NPT)	
Body material	Transmitter	ABS
	Sensor	PVC
	Warning Light	Poly Carbonate

3.3. Electrical Specifications (Standard Type)

ITEMS	SPECIFICATION	
Input Voltage(AC Type/Standard)	Absolute min: Nominal: Absolute max:	AC 90V AC 220V AC 250V
Input Voltage(DC Type) ※ Customer supplied PSU must meet requirements IEC1010-1 and CE Marking requirements.	Absolute min: Nominal: Absolute max: Ripple maximum allowed:	18V 24V 31V 1V pk-pk
Wattage(DC Type)	Max. wattage: Max. current:	6.72W @+24 VDC 280mA @+24 VDC
Analog output Current	0-20mA(500 ohms max load) All readings ± 0.2mA Measured-value signal: 4mA(Zero) to 20mA(Full Scale)	
	Fault: 0-100% LEL: 100-109%LEL: Over 110% LEL: Maintenance:	0mA 4mA - 20mA 20mA - 21.4mA 21.6mA 3mA
Analog output current ripple & noise max	±20uA	
Relay contact	Alarm1, Alarm2, Alarm3, Fault Relay Rated 1.0 A @ 30VDC or 0.5 A @ 125 VAC	
Wiring requirement	Power	CVVS or CVVSB with shield
	Analog	CVVS or CVVSB with shield
	RS485	STP(Shielded Twisted Pair)
Cable Connection Length	Analog	2500m
	RS485	1000m
EMC Protection:	Complies with EN50270	

3.4. Environmental Specifications

ITEMS	SPECIFICATION	
Operation Temperature	Transmitter	-20 to 60 °C
	Sensor	Refer to Sensor Specification
Storage Temperature	Transmitter	-20 to 60 °C
	Sensor	Refer to Sensor Specification
Operation Humidity	Transmitter	5 to 99% RH (Non-condensing)
	Sensor	Refer to Sensor Specification
Pressure Range	90 to 110KPa	
Max. air velocity	6m/s	

4.1. Components

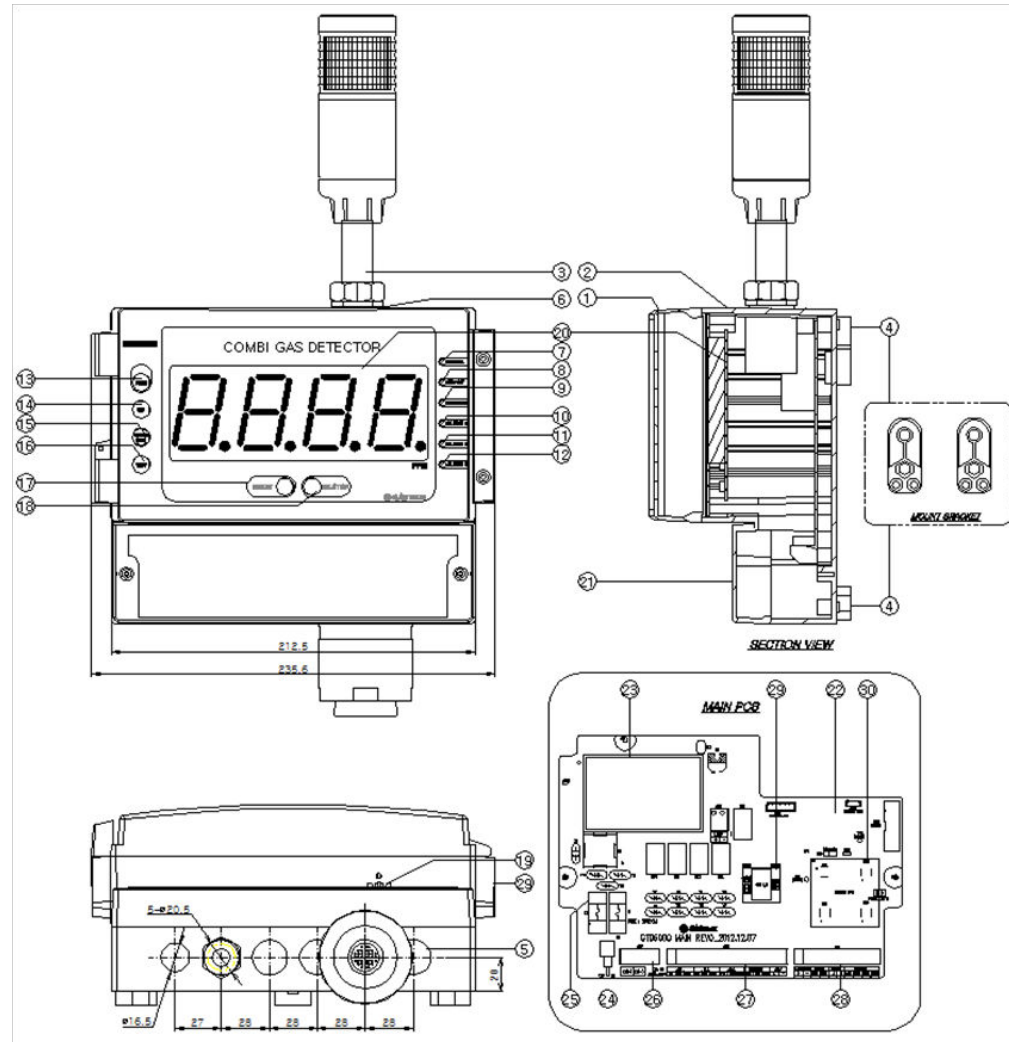

[Figure 2. GTD-6000 Components]

NO	NAME	DESCRIPTIONS
1	Case cover	It is made of ABS Material. It fixes the display and protects the circuit from surrounding environment and external shock.
2	Case body	It is made of ABS Material. It fixes the Main PCB and protects the circuit from surrounding environment and external shock.
3	Warning Light	Lights on upon an event of alarm.
4	Mount Boss	It is a bracket hole to fix the product on wall or other mount hole. It consists of 2 of Ø4.4 hole.
5	Conduit connection	1 hole of Ø16.5 and 5 holes of Ø 20.5 are set at the bottom part. Depending on site condition, power and signal cables, etc. are connected by cable inlet.
6	O-Ring	It works as waterproofing material to prevent rainwater from entering inside. It is made of NBR material.
7	Power LED	When power is supplied normally, the power LED lights on.
8	Stand-by LED	When the detector is in stand-by mode, LED flickers.
9	Fault LED	It lights on in an event of trouble.
10	Alarm 3 LED	It lights on in an event of Alarm 3.
11	Alarm 2 LED	It lights on in an event of Alarm 2.
12	Alarm 1 LED	It lights on in an event of Alarm 1.
13	Function KEY	It is a key to convert or set a mode in function setting mode. When FUNC key is pressed for 2 sec or longer in measuring mode, it enters function setting menu mode. (Configuration, Program, Calibration, Alarm, etc.)
14	UP KEY	It is a key to increase a set value in function setting mode.
15	DOWN KEY (Stand-by)	It is a key to decrease a set value in function setting mode. When down key is pressed for 2 sec longer in measuring mode, it enters test mode (EMS: Emergency Maintenance System). STD-BY LED flashes. In stand-by mode, pressing down key for 2 sec or longer releases it.
16	TEST KEY	Pressing "TEST" key enters a mode that performs self-test. Measurement FND flickers and the value can be adjusted using "TEST" key to check the alarm operation status.
17	RESET KEY	To change into menu mode or measuring mode from function setting mode, use reset key to return.
18	Buzzer Stop KEY	Used to stop buzzer in an event of alarm.
19	Buzzer	Operates in a continuous tone upon an event of warning or fault during a test.
20	FND PCB Ass'y	Displays measurement from detector in a continuous manner. During test, it displays user defined value with flickering.
21	Terminal Block Cover	To supply power to the equipment, open the terminal block cover and connect power cable.
22	Main PCB	Amplifies fine outputs generated from Sensor Element to transmit a converted output in 4~20 mA DC standard. It sends data to display part.
23	SMPS	It is a converter that changes 220 V AC to 24 V DC.
24	Power ON/OFF Switch	It is a switch used to turn ON and OFF of the control unit power. When performing cable wiring work, power must be turned OFF.
25	FUSE	It works as a breaker to protect the equipment by disconnecting power when overcurrent flows.

NO	NAME	DESCRIPTIONS
26	Power Input Terminal (CN7)	It is a terminal for external power cable connection.
27	Signal output terminal (CN5)	Used for connecting cables, etc. for Relay Dry Contract Signal Output such as warning, failure, etc. and Switch Signal Output, etc.
28	Signal I/O terminal (CN6)	Used for connecting cables, etc. for power supply of gas sensor, 4~20 mA current output, and RS-485 MODBUS Network, etc.
29	Cover Fixing Button	Device to fix the cover on the case body. To open the cover, push the hook and pull the cover towards the front.
30	RS-485 module(Optional)	RS-485 network module is isolated type that connects PC and other external network devices to receive and transmit the current concentration and settings, etc.
31	Sensor PCB	Sensor operation board that is set by combustible and toxic gas sensor.

[Table 1. GTD-5000F Component Description]

- It is prohibited for an individual, other than an approved user or a technician responsible for installation and repair from the head office, to install a gas leak sensor on site or open the cover of the installed gas leak sensor and manipulate it. This may cause serious loss of life and property from fire, explosion, and etc. In addition, please check whether there is any remaining explosive gas or combustible material in the surroundings. Power must be turned off before performing work.

5.1. Detachment of Terminal Block Cover

- Loosen the set screws at each side of terminal block cover located front bottom of the product then detach the cover. Terminal block for power and various signal connection in Terminal PCB appears.

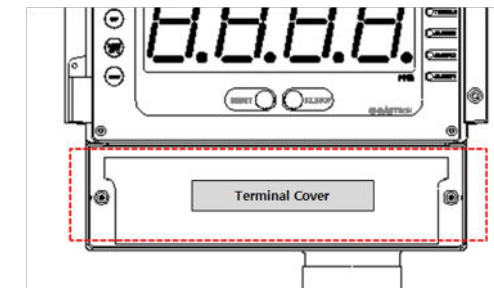

[Figure 3. Terminal Block Cover Configuration]

5.2. Power Terminal Configuration

- After detaching terminal block cover, configure power using CN7 terminal built on the left side of Terminal PCB. The configured power is connected using CN9 and is convenient for supplying power to external devices.

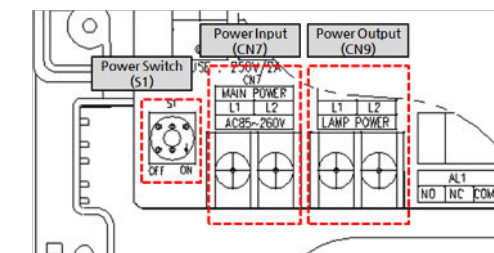

[Figure 4. Power Terminal Configuration]

- Connected power can be turned ON/OFF using S1 switch.
- The product has AC power as a default setting. When it is desired to use DC24V, a separate request must be made when ordering the product. When the product has been delivered as DC24V Type upon a customer request, (+) and (-) of DC24V shall be connected to L1 and L2, respectively.

Terminal	PIN NAME	DESCRIPTION	
		AC MODE	DC MODE
CN7	L1	AC220V L1	POWER+(24V)
	L2	AC220V L2	POWER-(GROUND)
CN9	L1	AC220V L1	POWER+(24V)
	L2	AC220V L2	POWER-(GROUND)

[Table 2. Power Terminal Detailed Description]

- Use CVVS or CVSB 1.5sq¹ Shield Cable for wiring.

5.3. Signal Terminal Configuration

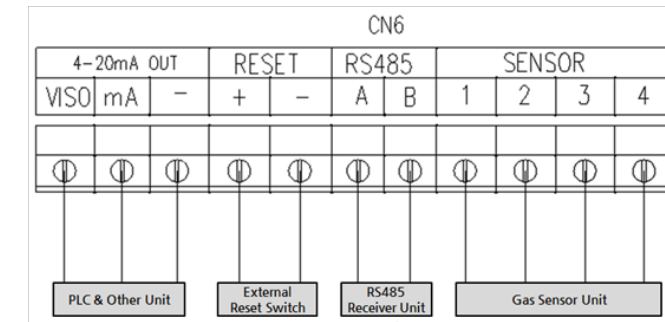

[Figure 5. Signal Terminal Configuration]

- Using CN6 terminal, connect 4~20 mA output, External Reset, RS485, and gas sensor. Terminal configuration is as shown in the table below.

Function	Terminal Name	Description
4-20mA Output	VISO	External power input terminal for 4~20 mA Sink Driver
	mA	Output terminal for 4~20 mA Source Driver
	-	4-20mA Common Terminal
RESET	+	External Reset S/W + Terminal. When + and - terminals short, alarm reset function operates.
	-	External Reset S/W - Terminal
RS485	A	RS485 A Terminal (TRXD+ or P)
	B	RS485 B Terminal (TRXD- or N)
SENSOR		Combustible Sensor Toxic Sensor O2 Sensor (Galvanic Method)
	1	Red Cable Blue Cable N.C
	2	White Cable Red Cable Red Cable
	3	Green Cable White Cable White Cable
	4	Blue Cable N.C N.C

[Table 3. Signal Terminal Description]

- Note 1) When RS485 Option does not exist, RS485 function does not operate.

5.4. Relay Terminal Configuration

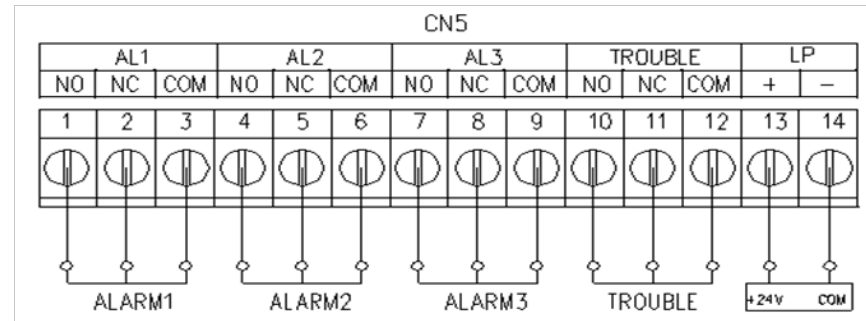

[Figure 6. Relay Terminal Configuration]

- Using CN5 terminal, it consists of 3 SPDT-type Alarm relay and 1 SPDT-type Trouble relay.
LP terminal output DC +24V power regardless of AC, DC power mode. This is to use an external DC flash light or external devices.

Function	Pin	Terminal Name	Description
4-20mA Output	1	NO	Alarm1 Normal Open
	2	NC	Alarm1 Normal Closed
	3	COM	Alarm1 Common
Alarm2	4	NO	Alarm2 Normal Open
	5	NC	Alarm2 Normal Closed
	6	COM	Alarm2 Common
Alarm3	7	NO	Alarm3 Normal Open
	8	NC	Alarm3 Normal Closed
	9	COM	Alarm3 Common
Trouble	10	NO	Trouble Normal Open
	11	NC	Trouble Normal Closed
	12	COM	Trouble Common
LP	13	+	External Power (DC 24 V) + Output
	14	-	External Power (DC 24 V) - Output

[Figure 7. Relay Output Description]

- When gas concentration is detected to be above the set value for alarm, alarm function counts the dwell time and if it is above the set dwell time, alarm function operates.
- Alarm relay turns on when it is above the alarm dwell time. When Alarm Latch Type is at "ON" mode and alarm function runs, the alarm status and gas concentration value stays at the maximum value. When gas concentration decreases below the alarm value, alarm does not get released and "RESET" S/W must be ran to release it.
- When Alarm Latch Type is OFF, Alarm is released automatically in accordance to gas concentration.

5.5. Installation Cable Length

- The maximum length between GTD -6000 and power supply is decided by wire specification.
- Max. Installation Length = $V_{MAXDROP} \div I_{MAX} \div WIRER/m \div 2$
- $V_{MAXDROP}$: Maximum Power Loop Voltage Drop (= Power Supply voltage - min operating voltage)
- I_{MAX} : Max. Current Value of GTD-6000
- $WIRER/m$: The resistance of the wire (ohms/meter value available in wire manufacturer's specification data sheet)
- Installation length example using 24 V power supply and 16 AWG is as follows.
- GTD-6000 minimum operating voltage = 18 Vdc
- $V_{MAXDROP} = 24 - 18 = 6V$
- $I_{MAX} = 0.28A(280mA)$
- $6 \div 0.28 \div 0.01318 \div 2 = 812.92m \approx 812m$

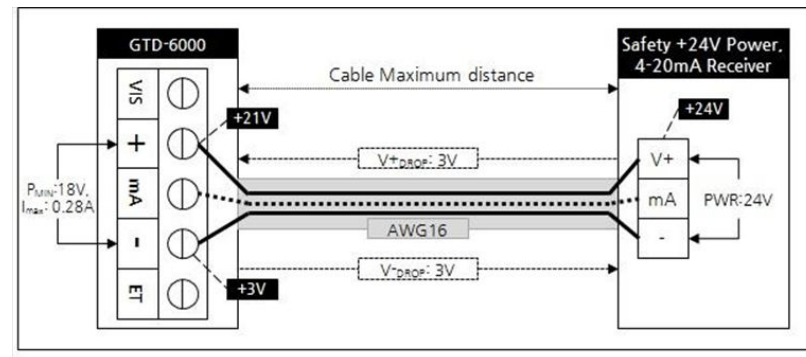

[Figure 8. GTD-6000 Installation Cable Length Calculation]

- Power cable installation for each cable type is as shown in the table below.

AWG	mm ²	COPPER RESISTANCE(ohms/m)	METERS
12	3.31	0.00521	2056
14	2.08	0.00828	1293
16	1.31	0.01318	812
18	0.82	0.02095	511
20	0.518	0.0333	321

[Table 4. GTD-6000 Power Cable Installation Length]

6.1. Initial Operation Status (Power On)

- After wiring to power terminal at the top of Terminal PCB board then supply power, the following contents are displayed on LCD. Approx. 30 min of stabilization of time is needed from the initial supply of operation power and it starts to operate normally after sufficient stabilization.

U000.0	- After GTC-6000 power turns ON, the current F/W version is displayed.
SELF	- After warming-up by "SELF" flashing for approx. 30 sec on FND of concentration display, it immediately enters the measurement mode. - If there is a trouble with the equipment at this time, fault alarm occurs.

6.2. Measuring Mode

- After power on, when there is no error from "SELF TEST", it automatically enters Measuring Mode.

0	- Displays gas concentration received by the detector on FND digital display in numbers.
FALt	- When the sensor is not connected, there is a problem with the sensor, or sensor PCB is not combined, "FALt" message flickers in 0.5 sec interval on the display.
Undr	- When the input value from the sensor is under 10% below the set high scale value, "Undr" displays and flashes at 0.5 sec interval. - Trouble LED lights on, warning light flashes, and buzzer sounds. - When "BZSTOP" KEY is pressed, warning light turns on and the buzzer stops.
oUEr	- When the input current from the sensor is over 10% above the set high scale value, "oUEr" displays and flashes at 0.5 sec interval. - Alarm 1, 2, 3 LED lights flickers, warning light flickers, and buzzer sounds.

6.3. Gas Test Function Operation

- Pressing "TEST" key for 2 sec or longer in gas concentration display mode enters Test mode. In test mode, when it passes 30 min after the last KEY control, it automatically returns to the gas concentration display mode.

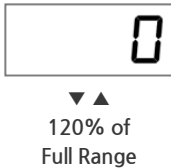
 <p>▼▲ 120% of Full Range</p>	<ul style="list-style-type: none"> When it enters Test mode, gas concentration number displays and flickers. This function enables testing at channel unit without injecting gas to the detector sensor. It can set an arbitrary concentration when the user presses "Test" key and alarm function operates normally with a user-defined concentration. When "FUNC" key is pressed 2 sec or longer, it enters FND / LED Test function. When "RESET" key is pressed, it returns to gas concentration display mode
--	--

6.4. Set-up Mode Entry Status

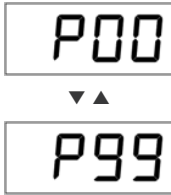
	<ul style="list-style-type: none"> Pressing "TEST" key for 2 sec or longer in gas concentration display mode enters Test mode. In program setting mode, when it passes 10 sec after the last Key control, it automatically returns to gas concentration display mode. It requires password. Factory setting is "00". "00" means that the password is not entered. After entering password, by pressing FUNC SW, each mode can be set. By using "UP" or "DOWN" KEY, the user can confirm in an order of Program -> Calibration -> Alarm -> Sensor -> Option -> Version -> Test mode.
---	---



6.5. Operation Flow









- After power on, it passes self-diagnostic process then enters Measuring Mode. Here, by operating front keys, you can go to internal System Mode.
- Timeout (time after the last key control) for Level1 and Level2 are 10 sec. It is set to 1 h for Level2 Calibration and Test Mode.
- When "RESET" key contacts at Program Mode Screen, it returns to Measuring Mode. When "RESET" key contacts at each Program Setting Screen, it returns to the parent step.

ITEM	NAME	DESCRIPTION
FUNC	Function key	Detector Mode Setting Entry Function (Enter Push key for 2 sec or longer in measuring mode) Level2 next stage entry function and setting value saving function
RESET	Reset key	Move to the previous stage from the level entered.
↑	Up key	Next level mode that is configured in LEVEL1 and Change in Level2 setting Plus
↓	Down key	Next level mode that is configured in LEVEL1 and Change in Level2 setting Minus

[Table 5. Operation Key Description]





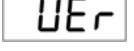
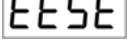

6.6. Menu Configuration Table





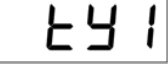
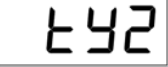
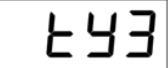
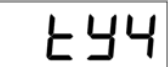
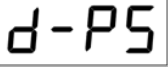

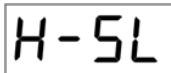

LEVEL1	LEVEL2	PARAMETER	DEFAULT	
PROGRAM MODE 	(Gas Funtion)	TY1, Ty2, TY3, TY4	TY1	
	(Decimal-Point)	100, 1.00, 10.0	100	
	(High-Scale)	10~9999	100	
	(Channel number)	1~128	1	
	(Pass Word)	0~99	0	
	(End)	-	-	
CALIBRATION MODE 	(Zero-Calibration)	NO , YES	NO	
	(0)	-	-	
	(good)	-	-	
	(0)	-	-	
	(Span-Calibration)	NO , YES	NO	
	(50)	-	-	
	(50)	Full Range 20~100	50%/F.R	
	(good)	-	-	
	(50)	-	-	
	(End)	-	-	
	ALARM MODE 	(LACH)	ON, OFF	ON
		(Energizer)	ON, OFF	OFF
(Alarm Lamp)		ON, OFF	OFF	
(AL-1)		0~Full range	20%/F.R.	
(1H)		H, L	H	
(1H 00)		0~99	0	
(AL1t)		0~30	1	
(A1rL)		ON, OFF	ON	
(A1br)		ON, OFF	OFF	
(AL-2)		0~Full range	40%/F.R.	
(2H)		H, L	H	
(2H 00)		0~99	0	
(AL2t)		0~30	1	
(A2rL)		ON, OFF	ON	
(A2br)		ON, OFF	OFF	
(AL-3)	0~Full range	50%/F.R.		
(3H)	H, L	H		

LEVEL1	LEVEL2	PARAMETER	DEFAULT
ALARM MODE 	 (3H 00)	0~99	0
	 (AL3t)	0~30	1
	 (A3rL)	ON, OFF	ON
	 (A3br)	ON, OFF	OFF
	 (End)	-	-
SENSOR MODE 	Do not Operate Refer to Factory Manual		
OPTION MODE 	Do not Operate Refer to Factory Manual		
VERSION MODE 	Do not Operate Refer to Factory Manual		
TEST MODE 	Do not Operate Refer to Factory Manual		

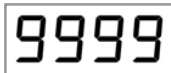
[Table 6. Menu Table Description]

7.1.PROGRAM MODE



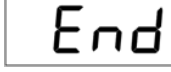



	<ul style="list-style-type: none"> - When "FUNC" KEY is pressed, it enters Program Mode. - When "RESET" KEY is pressed, it returns to gas concentration display mode
	<ul style="list-style-type: none"> - It is gas selection function that can be selected by gas type. - When "FUNC" KEY is pressed, it enters gas selection function. - When "RESET" KEY is pressed, it returns Program Mode.
	<ul style="list-style-type: none"> - For each TY selection, High-Scale, d-PS, Alarm (1, 2, 3), Alarm direction, Stand-by mode output, Sensor output characteristic direction, Temperature compensation functions change accordingly. - Decimal point position is set by pressing "UP" KEY or "DOWN" KEY where it changes as shown on the left. (Default TY1) - Value that changes upon TY1 selection (Ex. Tx) - Decimal position setting -> Default 0, Max. gas concentration display possible -> Default 100 - Alarm threshold 1 -> 20 H, 2 -> 40 H, 3 -> 50 H - Stand-by output -> Default 0, Sensor output characteristic direction -> Default dec - Temperature compensation function -> Default OFF
	<ul style="list-style-type: none"> - Value that changes upon TY2 selection (Membrapor O2) - Decimal position setting -> 1 (25.0) Max. gas concentration display possible -> 250 - Alarm threshold 1 -> 18.0 L, 2 -> 15.0 L, 3 -> 23.0 H - Stand-by output -> Default 20.9, Sensor output characteristic direction -> Default inc - Temperature compensation function -> Default ON
	<ul style="list-style-type: none"> - TY3 and TY4 are back up and not used currently. - When a desired TY is displayed, press "FUNC" KEY to set TY and enter the next item. - When "RESET" KEY is pressed, it returns Program Mode.
	
	<ul style="list-style-type: none"> - It is decimal position setting mode, which is the first function in program data setting mode. - When "FUNC" KEY is pressed, it enters decimal setting mode. - When "RESET" KEY is pressed, it returns Program Mode.
	<ul style="list-style-type: none"> - Decimal point is used when it is necessary to change decimal point for measured range. Decimal point position is set by pressing "UP" KEY or "DOWN" KEY where it changes as shown on the left. (Default 100) - Ex)100, 10.0, 1.00, 0.100 - When a desired decimal place is displayed, press "FUNC" KEY to set the decimal place and enter the next item. - When "RESET" KEY is pressed, it returns Program Mode.
	
	
	

	<ul style="list-style-type: none"> - It is High scale setting mode, which sets the max. gas concentration to be displayed. - High scale value is set in accordance to the domestic regulations as factory setting. - When "FUNC" KEY is pressed, it enters high scale setting mode. - When "RESET" KEY is pressed, it returns Program Mode.
	<ul style="list-style-type: none"> - High scale changes a set value according to measuring range. Scale value increases or decreases upon pressing "UP" KEY or "DOWN" KEY, respectively. (Default 100) - When a desired high scale is displayed, press "FUNC" KEY to set it and enter the next item. - When "RESET" KEY is pressed, it returns Program Mode.
	<ul style="list-style-type: none"> - This setting mode is configured with the same measuring range as gas detector when delivered. Ex.) When range is set to 100. For 4 mA/DC output ... 0 Display For 20 mA/DC output ... 100 Display
	<ul style="list-style-type: none"> - It is channel Number Setting Function that sets Serial Number of Control Unit. - When "FUNC" KEY is pressed, it enters Channel number setting mode. - When "RESET" KEY is pressed, it returns to gas concentration display mode
	<ul style="list-style-type: none"> - Channel number is a mode that enters serial number of control unit to enable recognition of operation status of each control unit at other equipment, such as PC, etc. Pressing "UP" KEY or "DOWN" KEY increase or decreases Address No. Value, respectively. (Default 1) - When a desired address no. is displayed, press "FUNC" S/W to set it and enter the next item. - Channel No is set at "1" as factory preset and is only entered when network function is to be used. - When two or more control unit is used, Channel No. shall not overlap.
	
	<ul style="list-style-type: none"> - It is password setting function. - When "FUNC" KEY is pressed, it enters Password setting mode. - When "RESET" KEY is pressed, it returns Program Mode.
	<ul style="list-style-type: none"> - By pressing "UP" or "DOWN" KEY, password value increases or decreases, respectively. (Default P00) - When a desired password no. is displayed, press "FUNC" KEY to set it and enter the next item. - When "RESET" KEY is pressed, it returns Program Mode.
	
	<ul style="list-style-type: none"> - A message indicating completion of setting is displayed as "End" for 2 sec then it returns to menu mode

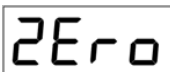
7.2. CALIBRATION MODE

- Due to characteristics of the gas detector, minimum 30 min of stabilization time is required and maintenance condition may change depending on site condition.

7.2.1. Zero Calibration

	<ul style="list-style-type: none"> - After pressing "FUNC" key for 2 sec or longer, it can be selected by using "UP" and "DOWN" keys after entering "Password". - It is a mode for zero calibration and span calibration - When "FUNC" KEY is pressed, it enters calibration setting mode. - When "RESET" KEY is pressed, it returns to gas concentration display mode
	<ul style="list-style-type: none"> - It corrects -350 mV~+350 mV (based on A/D input voltage) voltage to 0. - When "FUNC" KEY is pressed, it enters zero setting mode. - When "RESET" KEY is pressed, it returns to Calibration Mode.
	<ul style="list-style-type: none"> - By pressing "UP" or "DOWN" KEY, "no" or "yes" is displayed. - Default is no.
	<ul style="list-style-type: none"> - When a desired item is displayed, press "FUNC" KEY to set and enter the next item. - When "RESET" KEY is pressed, it returns to Calibration Mode.
	<ul style="list-style-type: none"> - Using a calibration tool, inject clean air or 100% nitrogen into the sensor at a flow rate of 1000 mL/min for 1 min. Contact "FUNC" key when measurement is stabilized to automatically perform Zero Calibration. - When "RESET" KEY is pressed, it returns to Calibration Mode.
	<ul style="list-style-type: none"> - If calibration is normal or defective, Good or Fail displays, respectively. - When "FUNC" KEY is pressed, it enters the next setting mode. - When "RESET" KEY is pressed, it returns to Calibration Mode.
	<ul style="list-style-type: none"> - It displays measurement with calibration completed. - When "FUNC" KEY is pressed, it enters the next setting mode. - When "RESET" KEY is pressed, it returns to Calibration Mode.



7.2.2. Span Calibration



SPAn	<ul style="list-style-type: none"> - After zero calibration, change to SPAN using "UP" and "DOWN" keys at CALI stage. - Start SPAN calibration. If it is above 5 mV from zero calibration value, it displays Good. If it is below, it displays Fail. - When "FUNC" KEY is pressed, it enters Span setting mode. - When "RESET" KEY is pressed, it returns to Calibration Mode.
no	<ul style="list-style-type: none"> - By pressing "UP" or "DOWN" KEY, "no" or "yes" is displayed. - Default is no.
YES	<ul style="list-style-type: none"> - When a desired item is displayed, press "FUNC" KEY to set and enter the next item. - When "RESET" KEY is pressed, it returns to Calibration Mode.
50	<ul style="list-style-type: none"> - Using a calibration tool, inject the standard gas to the sensor at a flow rate of 500 mL/min for 90 sec. After the measurement is stabilized, press "FUNC" key to enter the next mode. - When "RESET" KEY is pressed, it returns to Calibration Mode.
50	<ul style="list-style-type: none"> - Standard Gas Value Setting (50% of Full range) - When "FUNC" KEY is pressed, it enters the next setting mode. - When "RESET" KEY is pressed, it returns to Calibration Mode.
Good	<ul style="list-style-type: none"> - If calibration is normal or defective, Good or Fail displays, respectively. - When "FUNC" KEY is pressed, it enters the next setting mode. - When "RESET" KEY is pressed, it returns to Calibration Mode.
50	<ul style="list-style-type: none"> - It displays measurement with calibration completed. - When "FUNC" KEY is pressed, it returns to Calibration Mode. - When "RESET" KEY is pressed, it returns to Calibration Mode.

7.3.ALARM Mode

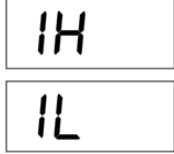
■ The following items are for Alarm 1 and mode setting for Alarm 2 and Alarm 3 are applied as the same.

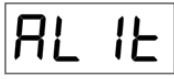
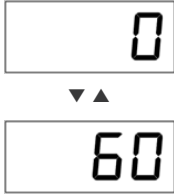
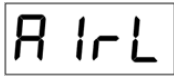
ALAR	<ul style="list-style-type: none"> - It can assign threshold for Alarm1, Alarm2, and Alarm3. - When "FUNC" KEY is pressed, it enters alarm setting mode. - When "RESET" KEY is pressed, it returns to gas concentration display mode
LACH	<ul style="list-style-type: none"> - It is a mode that sets Alarm Latch Type. - When "FUNC" KEY is pressed, it enters Alarm Latch Type setting mode. - When "FUNC" KEY is pressed, it enters Alarm Setting Mode.
on	<ul style="list-style-type: none"> - It is a mode to change alarm reset type and "ON" and "OFF" mode changes when "UP" or "DOWN" KEY are pressed. - When a desired alarm latch type is displayed, press "FUNC" KEY to set it and enter the next item. - When "FUNC" KEY is pressed, it enters Alarm Setting Mode. - Alarm Latch Type has two modes; "ON" and "OFF". "OFF" mode automatically resets alarm. When "ON", the user must press "RESET" KEY to release and reset the alarm.
off	
EnS	<ul style="list-style-type: none"> - It is a function that sets Energizer Modes for Alarm Relay and Fault Relay. - When "FUNC" KEY is pressed, it enters Energizer Mode setting mode. - When "FUNC" KEY is pressed, it enters Alarm Setting Mode.
on	<ul style="list-style-type: none"> - ON/OFF of Energizer Mode is determined by "UP" KEY or "DOWN" KEY. - When ON, it is in Normal Open (NO) status. - When OFF, it is in Normal Close (NC) status. - When a desired energizer mode is displayed, press "FUNC" KEY to set it and enter the next item. - When "FUNC" KEY is pressed, it enters Alarm Setting Mode.
off	
ALP	<ul style="list-style-type: none"> - Mode that sets external warning lights to operate with a desired alarm. - When "FUNC" KEY is pressed, it enters alarm lamp setting mode. - When "FUNC" KEY is pressed, it enters Alarm Setting Mode.
on	<ul style="list-style-type: none"> - Using "UP" and "DOWN" keys to display a desired alarm, then press "FUNC" key to set it. - By default, it is set at "ON". - When Alarm goes off when Alarm Lamp is ON, warning light lights on. When it is OFF, warning light is off. - When a ALP value is displayed, press "FUNC" KEY to set and enter the next item. - When "FUNC" KEY is pressed, it enters Alarm Setting Mode.
off	
AL-1	<ul style="list-style-type: none"> - Alarm 1 threshold setting function message is displayed as "AL-1" - When "FUNC" KEY is pressed, it enters Alarm1 threshold setting mode. - When "RESET" KEY is pressed, it returns to Alarm Setting Mode.

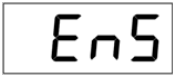
 Full Range	<ul style="list-style-type: none"> - Function to change Alarm 1 threshold setting. Max. allowable is high scale value. Pressing "UP" KEY or "DOWN" KEY increases or decreases Alarm1 value, respectively. - When a desired alarm 1 threshold is displayed, press "FUNC" KEY to set it and enter the next item. - When "RESET" KEY is pressed, it returns to Alarm Setting Mode. - (Default: Alarm1 = 20(F/S 20%), Alarm2 = 40(F/S 40%), Alarm3 = 50(F/S 50%))
	<ul style="list-style-type: none"> - Alarm level is set to the concentration outlined in domestic regulations as factory setting. - It is a mode to set a direction of Alarm 1 operation. Pressing "UP" KEY or "DOWN" KEY displays "1H" or "1L", respectively. - "1H" mode operates when gas value is equal or greater than Alarm1 setting value. "1L" mode operates when gas value is equal or less than Alarm1 set value. - When a desired mode is displayed, press "FUNC" KEY to set and enter the next item. - When "RESET" KEY is pressed, it returns to Alarm Setting Mode.
	<ul style="list-style-type: none"> - It is a mode to set a dead band for Alarm 1 operation. Pressing "UP" KEY or "DOWN" KEY increases or decrease the value, respectively. (Default 0) - When Alarm 1 is in "1H" mode, Alarm 1 operates at values above the sum of Alarm and dead band values and releases below the sum. - When Alarm 1 is in "1L" mode, Alarm 1 operation below difference of Alarm and dead band values and releases above the difference - When a desired Alarm1 dead band value is displayed, press "FUNC" KEY to set it and enter the next item. - When "RESET" KEY is pressed, it returns to Alarm Setting Mode.
	<ul style="list-style-type: none"> - It is a mode to set Alarm1 dwell time. - It is a function to prevent instantaneous malfunction of detector due to external shock and noise other than from normal operation. - When "FUNC" KEY is pressed, it enters Alarm1 dwell time setting mode. - When "RESET" KEY is pressed, it returns to Alarm Setting Mode.
	<ul style="list-style-type: none"> - To change Alarm 1 dwell time, pressing "UP" KEY or "DOWN" KEY increases or decreases the time in unit of seconds (Default 1) - Ex.) Alarm threshold value: 20%LEL/delay Time: When it is at 5 sec, Alarm triggers when the measured value is above the set value based on 20%LEL for 5 sec or longer. When it goes down below the setvalue within 5 sec, alarm is not triggered. - When a desired Alarm 1 dwell time is displayed, press "FUNC" KEY to set it and enter the next item. - When "RESET" KEY is pressed, it returns to Alarm Setting Mode.
	<ul style="list-style-type: none"> - It is a mode to set Alarm1 contact output. - When "FUNC" KEY is pressed, it enters Alarm1 contact output setting mode. - When "RESET" KEY is pressed, it returns to Alarm Setting Mode.

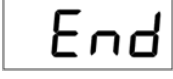
	<ul style="list-style-type: none"> - It is a mode to change Alarm1 contact output and "ON" and "OFF" mode changes when "UP" or "DOWN" KEY are pressed. - Alarm1 contact output mode has two modes: "ON" and "OFF". In OFF mode, Alarm 1 contact output does not run. In ON mode, it runs. - When a desired Alarm 1 contact output mode is displayed, press "FUNC" KEY to set it and enter the next item. - When "RESET" KEY is pressed, it returns to Alarm Setting Mode.
	<ul style="list-style-type: none"> - Alarm 1 blink output setting function that sets Alarm1 contact output to go ON/OFF at 1 sec interval during buzzer operation. - When "FUNC" KEY is pressed, it enters Alarm1 blink output setting mode. - When "RESET" KEY is pressed, it returns to Alarm Setting Mode.
	<ul style="list-style-type: none"> - It is a mode to change Alarm1 blink output and "ON" and "OFF" mode changes when "UP" or "DOWN" KEY are pressed. - Alarm1 blink output mode has two modes: "ON" and "OFF". In OFF mode, Alarm 1 blink output does not run. In ON mode, it runs. (However, it runs when Alarm1 contact output mode is ON.) - When a desired Alarm 1 blink output mode is displayed, press "FUNC" KEY to set it and enter the next item. - When "RESET" KEY is pressed, it returns to Alarm Setting Mode.
	<ul style="list-style-type: none"> - A message indicating completion of setting is displayed as "End" for 2 sec then it returns to gas concentration display status.

8.1. Fault List

FAULT MESSAGE	DESCRIPTION & CONDITION	CAUSE
[FAULT-02]	Toxic sensor output is above ADC max. value.	Defective sensor module or transmitter board ADC
[FAULT-03]	Toxic sensor output is below ADC min. value.	Defective sensor module or transmitter board ADC
[FAULT-04]	Defective Transmitter EEPROM Checksum	Defective Transmitter board EEPROM
[FAULT-05]	It occurs when 24 V main input power is inputted with voltage below 10 V.	Check power input and defective Transmitter ADC
[FAULT-06]	Defective Transmitter ADC	Defective Transmitter ADC
[FAULT-07]	H/W Version Error	Defective MPU inside Transmitter
[FAULT-08]	When there is repeated hunting error in gas measurement	Sensor output status may be poor or check for input power noise.

[Table 7. Fault List]

8.2. Recovery List

NO	CAUSE	SOLUTION
1	Defective Sensor Module	Change Sensor
2	Defective Transmitter Board ADC	Change Transmitter Board
3	Defective Transmitter Board EEPROM	1) Perform Factory Initialization then correct parameter and re-calibrate 2) Change sensor unit when the same problem occurs again
4	Defective MPU inside Transmitter	Change Transmitter Main Board
5	Poor Sensor Output Status	Change Sensor
6	Check Input Power Noise	Check External Input Voltage Noise Status

[Table 4. Recovery List]

9.1. MODBUS RS485

9.1.1. Interface setting

- Data Format: RTU
- Baud rate: 9600 bps
- Data bits: 8bits
- Stop bit: 1bits
- Parity: Even
- For details, please go to www.modbus.org

9.1.2. MODBUS RS485 Register map

TYPE	ADDRESS	BITS	DESCRIPTION
Measured Gas Concentration	30001	BIT15~0	Gas Measurement (Integer/Decimal point is not considered)
High Scale Setting	30002	BIT15~0	High Scale Setting (Integer/Decimal point is not considered)
Alarm 1 Setting	30003	BIT15~0	Alarm 1 Setting (Integer/Decimal point is not considered)
Alarm 2 Setting	30004	BIT15~0	Alarm 2 Setting (Integer/Decimal point is not considered)
Gas detector status value	10000	BIT0	Alarm 1 Active Status
		BIT1	Alarm 2 Active Status
		BIT2	Fault Active Status
		BIT3	Maintenance Mode Status
		BIT4	Test Mode Status
		BIT5	Calibration Mode Status
		BIT6	Reserved
		BIT7	Toggle Bit (Bit reversal in 2 sec interval)
External Test	3	BIT0~7	Gas Detector Test Mode Setting
External Reset	2	BIT0~7	Exit Gas Detector Test Mode

[Table 8. RS485 MODBUS Address Configuration]

10.1. Drawing 1

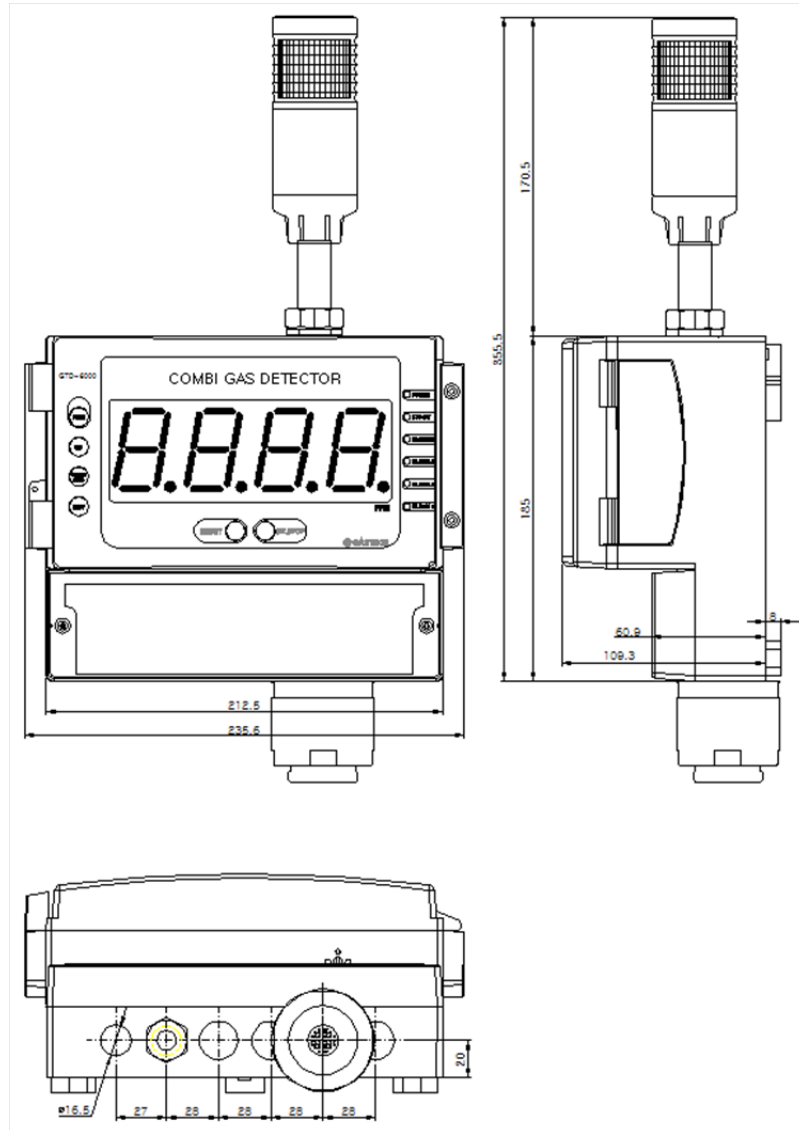

[Figure 9. GTD-6000 Drawing 1]

10.1. Drawing 2

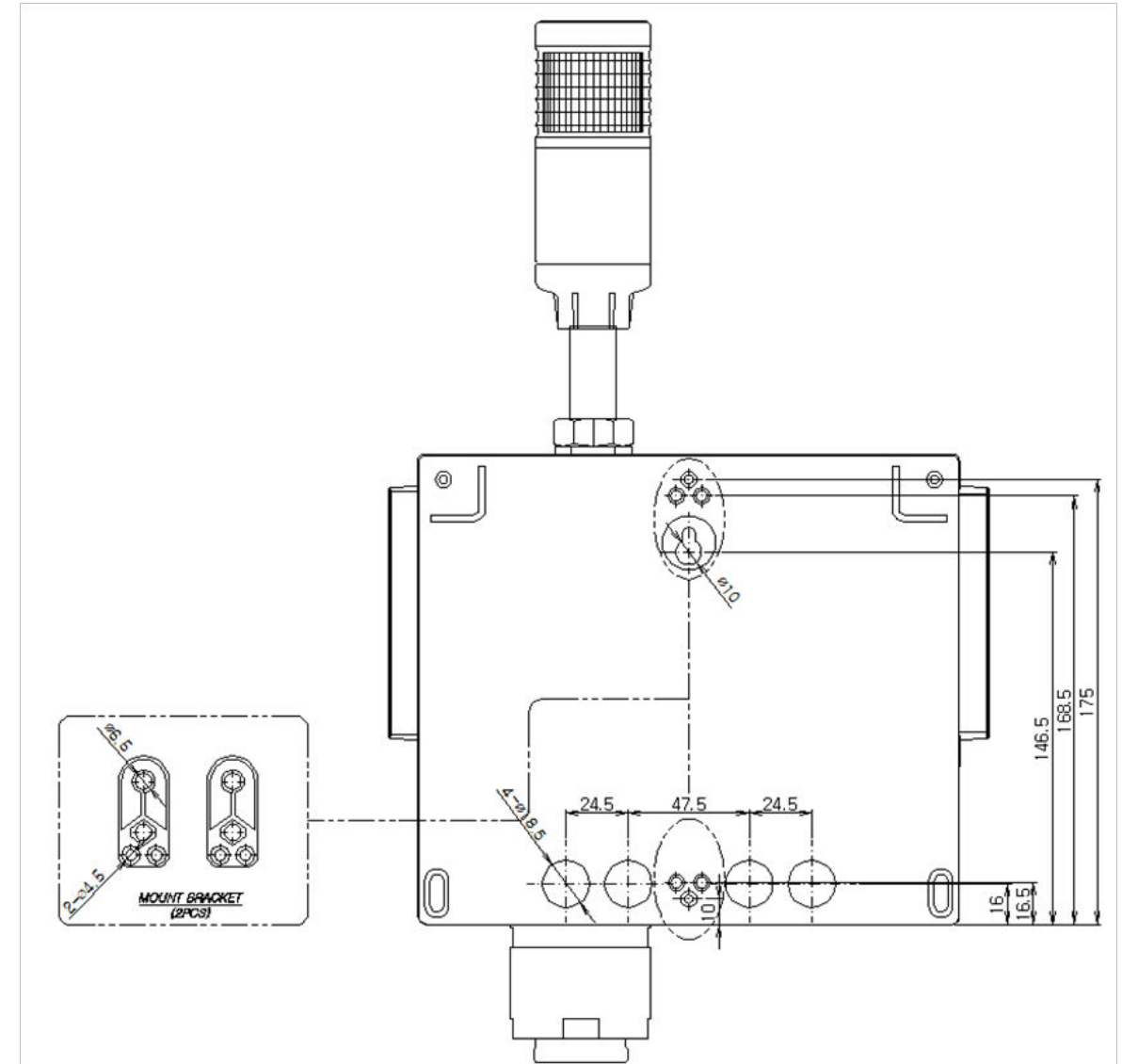

[Figure 10. Drawing 2]

11.1. Selecting a Place for Installation (Occupational Health & Safety Act Data)

A gas leak detector alarm shall be installed in the following places.

- Around chemical equipment and accessories that have concerns of gas leak. This includes compressors, valves, reactors, pipe joints, etc. installed inside and outside of a building that handle combustible and toxic materials.
- Places that are easier for gases to stay such as areas around manufacturing facilities with ignition sources like heating furnace, etc,
- Areas around equipment for filling combustible and toxic materials.
- Substations, panel rooms, control rooms, and etc. located within explosive area.
- Other areas that are easier for gases to stay.

11.2. Selecting a Site for Installation (High-Pressure Gas Safety Control Act Data)

Gas detector of gas leak detector alarm must be installed as close to the areas with concerns of gas leakage as possible. However, for areas where direct gas leakage is not expected but are easier for leaked gas to stay, the detector must be installed at the point 1 of the following.

- Gas leak detector alarm installed outside a building shall be installed at points where gas is likely to stay in consideration to wind direction, wind speed, specific gravity of gas, etc.
- Gas leak detector alarm installed inside a building shall be installed near the floor when the specific gravity of gas is heavier than air and near ventilation of ceiling when it is lighter than air.
- Alarm for gas leak detector alarm must be installed at sites where the gas detector is installed and workers are present.

11.3. Precautions during Installation

Gas detector does not have closed construction, therefore, avoid area with electrical barriers such as rainwater, etc. for installation. If rainwater, etc. enters monitoring part, it may lose its function. If necessary, accessories including rain cover, etc. can be used.

- Avoid areas with vibration or shock.
- Areas with vibration or shock can affect the output value.
- Avoid areas with high temperature and humidity for installation.
- High temperature and humidity may cause malfunction.

- Avoid electronic noise for installation. Avoid areas with high frequency or high voltage as much as possible for installation. (Ex.: Areas close to motor, pump, high voltage cables, etc.)
- Install in areas where maintenance is convenient. Regular maintenance and correction is required for gas detector. Avoid areas where it is inconvenient for maintenance work.

VERSION	CONTENTS	DATE
0.0	* Initial Revision of the manual	2013.06.01
1.0	* Changed PCB and Added Function	2014.04.09
2.0	* Added Maintenance Function	2016.03.19
3.0	* Changed Font	2016.08.16
4.0	* Separated Factory Mode Manual	2016.09.27
4.1	* Corrected typo and error	2017.02.20
4.2	1> Corrected typo and error 2> Changed condition for sensor fault 3> Removed hot-wire-type semiconductor and PID from sensor measurement method	2017.03.02